

07 Proyecplan

- ES| Presentación visual
- GB| Visual presentation
- FR| Présentation visuelle
- DE| Visuelle Kommunikation
- IT| Presentazione visuale
- PO| Apresentação visual



es| Presentación visual
La presentación visual tanto en la empresa como en el mundo de la comunicación (ferias, congresos, etc...) es cada vez más un elemento indispensable en nuestras compañías. La gama PROYECPLAN, pone a su disposición un amplio surtido de pantallas murales y de trípode, soportes para videoproyectores, mesas y carritos para audiovisuales. La calidad de las telas de las pantallas así como los motores de nuestras pantallas motorizadas, son de alta calidad consiguiendo prolongar la vida útil de los equipos.



es| Visual presentation
This range of products offers a large choice of screens for wall and tripods, supports for video projectors, tables, and trolleys for audiovisual tools which are nowadays essential to businesses, exhibitions,... This range of products proposes a high quality of motorized screens and canvass screen which guarantee a long life to all projection products proposed in this section.



fr| Présentation visuelle
Les présentations audio-visuelles au sein de l'entreprise ou dans le monde de la communication (salons, foires, publicité...) sont de plus en plus indispensables. La famille ProyecPlan présente un mobilier de projection et audio-visuel, des écrans de projection (manuels, à moteurs, sur trépieds...) des vidéo-projecteurs avec différents supports. Ces produits sont modernes et actuels aussi bien pour leur design que la technologie mise en oeuvre pour les fabriquer. Les toiles des écrans sont traitées contre feu.



de| Visuelle Kommunikation
In der Firma sowie in der Kommunikationswelt (Messen, Kongresse, etc.) ist eine auffällige visuelle Präsentation ein wesentliches Element. PROYECPLAN Produktpalette stellt ein ausgeglichenes Angebot von Wand- und Stativleinwände, Projektionsstativ, Projektionswagen und Rednerpulte zur Verfügung. Die Gewebequalität der Leinwände und die Motoren der elektrischen Projektionsleinwände sind von der äußersten Qualität und sie sichern eine lange Lebensdauer der Produkte.



pt| Apresentação visual
This range of products offers a large choice of screens for wall and tripods, supports for video projectors, tables, and trolleys for audiovisual tools which are nowadays essential to businesses, exhibitions,... This range of products proposes a high quality of motorized screens and canvass screen which guarantee a long life to all projection products proposed in this section.

po| Apresentação visual
A apresentação visual tanto na empresa como no mundo da comunicação (feiras, congressos, etc...) é cada vez um elemento mais indispensável nas nossas empresas. A gama PROYECPLAN, coloca à sua disposição um amplo sortido de telas para parede e de chão com tripé, suportes para videoprojetores, mesas e carros para audiovisuais. As telas assim como os motores das nossas telas motorizadas, são de alta qualidade conseguindo assim uma maior duração da vida útil dos equipamentos.



MIMIO^{PS} TEACH



ES - Pizarra blanca no incluida.
GB - Whiteboard not included.
FR - Tableau blanc non inclus.
DE - Whiteboard nicht eingeschlossen.
IT - Lavagna bianca non incluso.
PO - Quadro branco não incluído.



310

311

A



MIMIO/T

ES - MIMIO-PS + Lápiz digital
GB - MIMIO-PS + digital pen

B



MIMIO/B

ES - Bateria externa 50 horas
GB - External battery 50 hours

C



MIMIO/L

ES - Lápiz MIMIO Teach Stylus
GB - Pencil MIMIO Teach Stylus

D



MIMIO/C

ES - Cargador de lápiz. USD CHARGUER STYLUS
GB - Pencil charger. USD CHARGUER STYLUS

E



MIMIO/CP

ES - Kit de captura (4 colores) + borrador
GB - Capture Kit (4 colors) + eraser

F



MIMIO/R

ES - Pack 4 uds. rotuladores (recambio)
GB - 4 units markers (spare part)

G



MIMIO/UC

ES - Tapa para MIMIO Teach. Universal Cover
GB - Cover for MIMIO Teach. Universal Cover

H



MIMIO/V

ES - MIMIO Viewer
GB - MIMIO Viewer

I

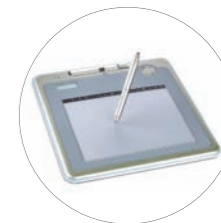

MIMIO/PD

ES - MIMIO Pad
GB - MIMIO Pad



pg. 318

ES | Dispositivo interactivo "MIMIO-PS"
Dispositivo interactivo Mimio TEACH PS, portátil. Convierte su pizarra blanca o verde tradicional en una PDI (Pizarra Digital Interactiva). Permite capturar instantáneamente todo lo que se escribe sobre ella y enviarlo a un PC. La escritura queda memorizada.

FR | Barre portable interactif "MIMIO-PS"
Dispositif portable Mimio Interactif TEACH PS. Transformez votre tableau blanc ou vert traditionnel en PDI (tableau blanc interactif). Capturez instantanément tout ce que vous écrivez dessus et l'envoyer vers un PC pour y être stocké.

IT | Sistema interattivo "MIMIO-PS"
Dispositivo interattivo Mimio TEACH PS, portatile. Converte la lavagna bianca o verde tradizionale in una LDI (Lavagna Digitale Interattiva). Permette di immagazzinare istantaneamente tutto ciò che si scrive e lo invia al PC. La scrittura resta memorizzata.

GB | Interactive portable system "MIMIO-PS"
Mimio Interactive device TEACH PS, portable. Turn your whiteboard or a traditional green PDI (interactive whiteboard). Instantly Capture everything you write on it and send it to a PC. The script is stored.

DE | Interaktive Einheit Mimio TEACH PS
Die interaktive Einheit Mimio TEACH PS, Laptop, verwandelt Ihre weisse oder grüne Tafel in eine "interaktive Tafel digital", alles was auf ihr geschrieben wird kann sofort auf Ihren PC übertragen. Das Geschriebene wird gespeichert.

PO | Quadro interativo "MIMIO-PS"
Dispositivo interativo Mimio TEACH PS, portátil. Converte o seu quadro branco ou verde tradicional num Quadro Digital Interativo. Permite capturar instantaneamente tudo o que se escreve sobre o quadro e envia a informação para um PC. O que se escreve fica memorizado.

eBeam^{PS}



A 720 AV

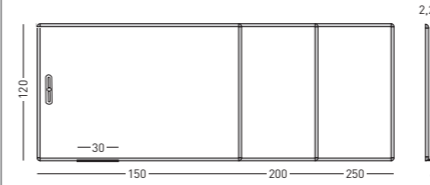

A	↑	↗	↖	⊗
EB/720/4/M	120	150	2,2	30
EB/720/6/M	120	200	2,2	30
EB/720/7/M	120	250	2,2	30

B 725 LM

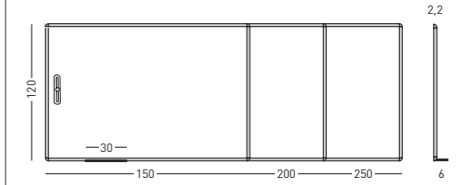

B	↑	↗	↖	⊗
* EB/725/4/M	120	150	2,2	30
EB/725/6/M	120	200	2,2	30
EB/725/7/M	120	250	2,2	30

C 720/T AV

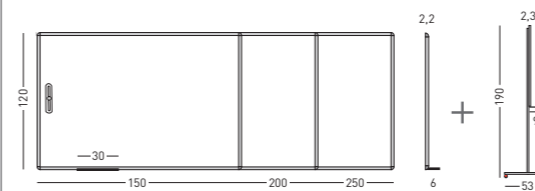

C	↑	↗	↖	⊗
EB/720/4/M/T	190	120 x 150	2,2	30
EB/720/6/M/T	190	120 x 200	2,2	30
EB/720/7/M/T	190	120 x 250	2,2	30

D 725/T LM

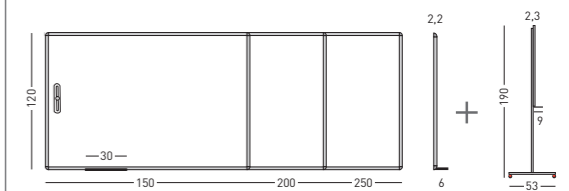

D	↑	↗	↖	⊗
* EB/725/4/M/T	190	120 x 150	2,2	30
EB/725/6/M/T	190	120 x 200	2,2	30
EB/725/7/M/T	190	120 x 250	2,2	30

E 720/Y2 AV

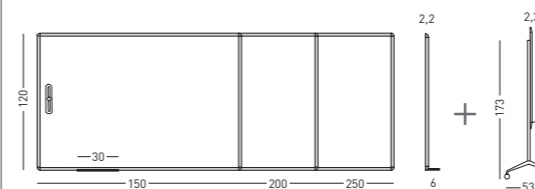

E	↑	↗	↖	⊗
EB/720/4/M/Y2	190	120 x 150	2,2	30
EB/720/6/M/Y2	190	120 x 200	2,2	30
EB/720/7/M/Y2	190	120 x 250	2,2	30

F 725/Y2 LM

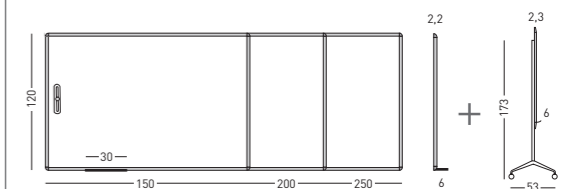

F	↑	↗	↖	⊗
* EB/720/4/M/Y2	190	120 x 150	2,2	30
EB/720/6/M/Y2	190	120 x 200	2,2	30
EB/720/7/M/Y2	190	120 x 250	2,2	30

* No apta para escritura con rotulador de borrado en seco.
* Not suitable for writing with dry erase marker.

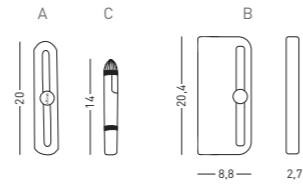
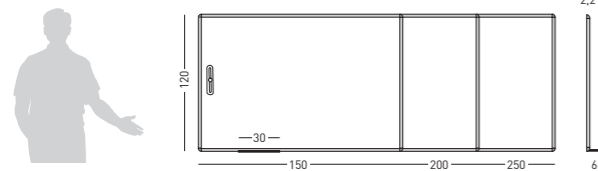

A	EB/EDGE	Capture	Dispositivo
B	EB/COVER	Cover	Tapa
C	EB/PEN	Pencil	Lápiz

es | Dispositivo interactivo eBeam EDGE
Dispositivo interactivo E-BEAM EDGE PS, portátil. Convierte su pizarra blanca o verde tradicional en una PDI (Pizarra Digital Interactiva). Permite capturar instantáneamente todo lo que se escribe sobre ella y enviarlo a un PC. La escritura queda memorizada.

fr | Barre portable interactif eBeam EDGE PS
Dispositif portable Interactif E-BEAM EDGE PS. Transformez votre tableau blanc ou vert traditionnel en PDI (tableau blanc interactif). Capturez instantanément tout ce que vous écrivez dessus et l'envoyer vers un PC pour y être stocké.

it | Dispositivo interattivo eBeam EDGE
Dispositivo interattivo E-BEAM EDGE PS, portatile. Converti la lavagna bianca o verde tradizionale in una LDI (Lavagna Digitale Interattiva). Permette di immagazzinare istantaneamente tutto ciò che si scrive e lo invia al PC. La scrittura resta memorizzata.

es | Interactive portable system eBeam EDGE
E-BEAM Interactive Device PS EDGE, portable. Turn your whiteboard or a traditional green PDI (interactive whiteboard). Instantly Capture everything you write on and send it to a PC. The script is stored.

de | Interaktive Einheit E-BEAM EDGE PS
Die interaktive Einheit Mimio E-BEAM EDGE PS, Laptop, verwandelt Ihre weisse oder grüne Tafel in eine "interaktive Tafel digital", alles was auf Ihr geschrieben wird kann sofort auf Ihren PC übertragen. Das Geschriebene wird gespeichert.

pt | Quadro interativo eBeam EDGE
Dispositivo interativo E-BEAM EDGE PS, portátil. Converte o seu quadro branco ou verde tradicional num Quadro Digital Interativo. Permite capturar instantaneamente tudo o que se escreve sobre o quadro e envia a informação para um PC. O que se escreve fica memorizado.



= EB/EDGE

FOCUS TOUCH



A LCD monitor

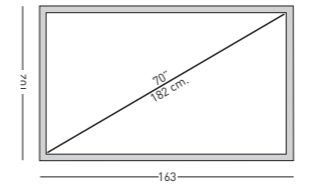

”	↕	↕	↔
FOC/LCD/70	70	51 x 82	39 x 70 14,8



B LED monitor

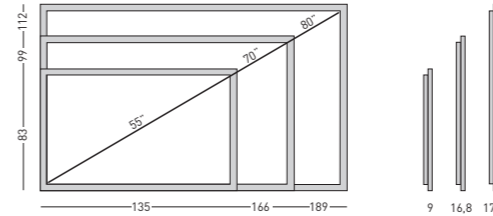

”	↕	↕	↔
FOC/LED/55	55	85 x 135	68 x 121 14,8
FOC/LED/65	65	99 x 166	87 x 154 13,5
FOC/LED/80	80	112 x 189	100 x 177 15



314



315

NEW

X acces



FOC/S
ES - Kit de limpieza
Ø - Clean Kit



FOC/SB
ES - Barra de sonido
Ø - Sound bar



FOC/P
ES - Puntero táctil
Ø - Touch pointer

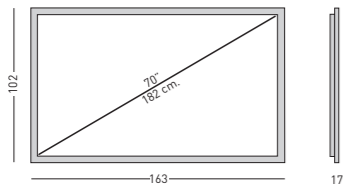

”	↕	↕	↔
FOC/LCD/70	70	51 x 82	39 x 70 14,8

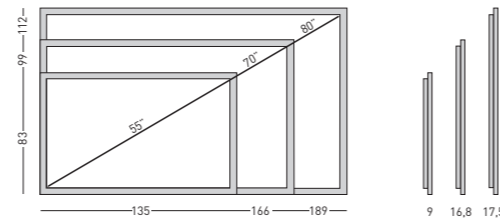

”	↕	↕	↔
FOC/LED/55	55	85 x 135	68 x 121 14,8
FOC/LED/65	65	99 x 166	87 x 154 13,5
FOC/LED/80	80	112 x 189	100 x 177 15

ES | Monitor táctil LCD Focus Touch
La completa gama de monitores HD incorporan la "dual optical touch technology". Ideal para presentaciones, formación etc... Disponible en tecnologías LCD y LED y desde 32" hasta 80".

FR | Moniteur tactile LCD Focus Touch
La gamme complète de moniteurs HD qui intègre la "double technologie tactile optique". Idéal pour les présentations formation... Disponible en qualité LCD ou LED et de 32" à 80".

IT | Monitore tattile LCD Focus Touch
La completa gamma di monitori HD include il "dual optical touch technology". Ideale per presentazioni, formazioni, etc. Disponibile con tecnologia LED da 32" a 80".

GB | LCD Focus Touch
The full range of HD monitors incorporate the "dual optical touch technology". Ideal for presentations, training etc ... Available in LCD and LED technologies and from 32" to 80".

DE | Komplette Auswahl von HD Bildschirmen
Die komplette Auswahl von HD Bildschirmen mit "dual optical touch technology". Ideal für Präsentationen, Schulungen etc... Erhältlich mit LCD und LED Technologie, von 32" bis 80".

PO | Monitor táctil LCD Focus Touch
A vasta gama de monitores HD incorporam a "dual optical touch technology". Ideal para apresentações, formação etc... Disponíveis com tecnologia LCD e LED, desde 32" até 80".

Interactive STAND



A
soporte



410/01 80 x 110 5

B
VPD
lente
corta



410/02 25 x 26 85 5

316



C
torre PC



410/04 22 x 42 45

D
sorporte
altavoces



410/05 10 x 15 x 8

317

E
soporte
pared



pg. 318-319

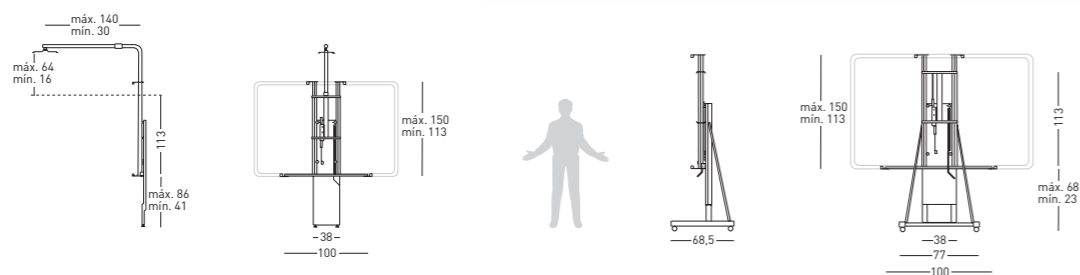

A	↑	↗	→
410/MM	100 x 300	100 x 170	25
410/ME	100 x 300	100 x 170	25

B	↑	↗	→
410/RM	100 x 218	100 x 136	68,5
410/RE	100 x 218	100 x 136	68,5

ES | Soporte para pizarra interactiva
Completa gama de soportes y accesorios para pizarras interactivas. Manuales o con accionamiento motorizado, en versión mural o sobre ruedas respectivamente. Ideal para centros de formación, empresas, etc...

FR | Supports pour tableaux interactifs
Une gamme complète de supports et d'accessoires pour tableaux blancs interactifs. Manuelle ou avec entraînement motorisé en version murale ou sur roulettes, respectivement. Idéal pour les centres de formation, entreprises...

IT | Supporto per lavagna interattiva
Gamma completa di supporti e accessori per lavagne interattive. Manuale o motorizzato, in versione da parete o con ruote. Ideale per centri di formazione, aziende, etc.

GB | Support for interactive whiteboard
Full range of brackets and accessories for interactive whiteboards. Manual or motorized drive on mural or wheeled version respectively. Ideal for training malls, companies, etc ...

DE | Halterungen interaktive Tafeln
Eine gamme complète de supports et d'accessoires pour tableaux blancs interactifs. Manuelle ou avec entraînement motorisé en version murale ou sur roulettes, respectivement. Idéal pour les centres de formation, entreprises...

PO | Suporte para quadro interactivo
Gama completa de suportes e acessórios para quadros interativos. Manuais ou elétricos, em versão de parede ou com rodas. Ideal para centros de formação, empresas, etc...



318



NEW

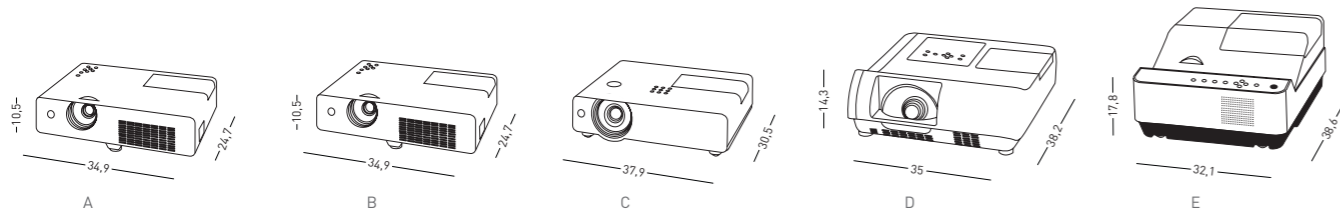

		↑	↓	Res.	Lm.
A	VPD/1	34,9 x 24,7	10,5	XGA	2.200
B	VPD/2	34,9 x 24,7	10,5	XGA	3.000
C	VPD/3	37,9 x 30,5	10,7	XGA	5.000
D	VPD/4	35 x 38,2	14,3	XGA	2.000
E	VPD/5	32,1 x 38,6	17,8	WXGA	2.500

ES | Videoproyectores

Videoproyectores compactos y portátiles de altas prestaciones indicado para instalaciones o presentaciones móviles. Estos proyectores tienen un uso polivalente tanto para la educación como en empresas por su portabilidad, y ofrecen gran luminosidad.

FR | Vidéo projecteurs

Gamme complète de vidéoprojecteurs polyvalent pour l'éducation et les entreprises. Performants, léger et très lumineux, vous trouver un produit adapté une entrée, un moyen et un haut de gamme.

IT | Video proiettore

Video proiettore compatto e portatile disponibile per tutti i tipi di proiezioni. Utilizzabile nelle scuole, università, aziende, o presentazioni di vendita, grazie ad un peso ultra leggero ed una alta luminosità in 3 modelli: Economico, Standard e Top.

GB | Video projector

Portable compact video projectors with high performance suitable for installations or mobile presentations. These projectors have a multipurpose use for education and for the company due to its portability, and offers high luminosity.

DE | Video-projektor

Leistungsstarker kompakter Beamer, sowie zur Befestigung als auch zu mobilen Präsentationen nutzbar. Durch seine mobile Einsatzmöglichkeit ermöglicht dieser einen Mehrzweckgebrauch nicht nur in Büros sondern auch in Schulen.

PO | Videoprojectores

Videoprojectores compactos e portáteis com alta qualidade, indicado para instalações ou apresentações portáteis. Estes projectores podem ter uma utilização polivalente, tanto para a educação, como em empresas, pela sua portabilidade, oferecem grande luminosidade.

319



NEW

13kg max

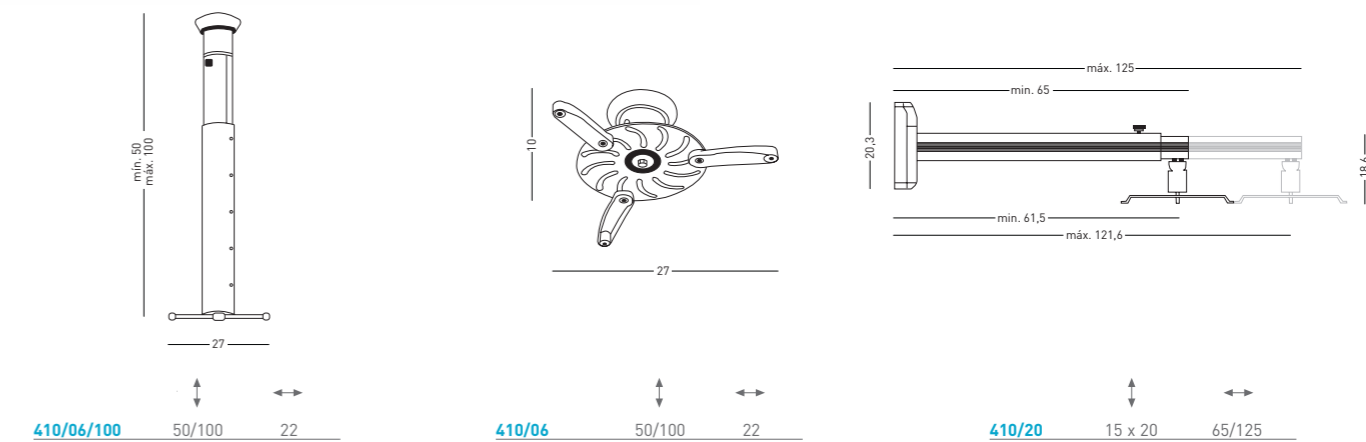

ES | Soporte techo basculante "Emineo"

Soporte metálico de fijación a techo para videoprojectores con un máximo de 13,6 kg. Acabado en color gris metalizado.

FR | Support plafond inclinable "Emineo"

Support métallique se fixant au plafond pour vidéoprojecteurs jusqu'à 13,6 Kg. Finition gris métallisé.

IT | Supporto da tetto basculante "Emineo"

Supporti metallici per fissaggio al soffitto per videoproiettori con un peso massimo di 13,6 kg. Rifinitura in colore grigio metallizzato.

GB | Orientable ceiling brackets "Emineo"

Ceiling brackets for videoprojector up to 13,6 Kg. Suitable for most of the projectors thanks to 3 or 4 arms mounting pattern. Easy to install thanks to a hook-in system.

DE | Deckenbefestigungssystem "Emineo"

Deckenbefestigungssystem für Beamer, maximales Gewicht 13,6 kg. Farbe grau-metallisch.

PO | Suporte de tecto basculante "Emineo"

Suporte metálico para fixação ao tecto, para videoprojectores com um máximo de 13,6 kg. Acabamento em cor cinzenta metalizada.

ZOOM

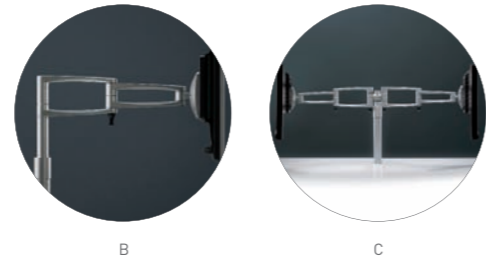

A

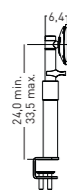

ION/Z/100 24 / 33,5 6,4



B

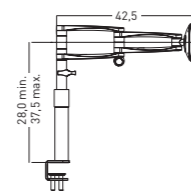

ION/Z/102 28 / 37,5 42,5



C

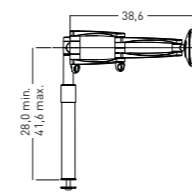

ION/Z/102/TW 28 / 41,6 38,6

E5 | Soporte pantalla de sobremesa "Zoom"
Serie ergonómica de brazos y soportes de sobremesa metálicos para pantallas de LCD / plasma hasta 28 pulgadas y un máximo de 20 kg. Incluyen sistema de extensión VESA y clip pasacables. Acabado en color gris metalizado.

FR | Support pour écran à poser "Zoom"
Platines murales universelles et supports de table pour écrans LCD/Plasma jusqu'à 28 pouces et 20 Kg. Comprend un système d'extension VESA et un anneau passe-cables électriques. Finition gris métallisé.

IT | Supporto schermo da tavolo "Zoom"
Serie ergonomica di bracci e supporti metallici da tavolo per schermo LCD/plasma fino a 28 pollici ed un massimo di 20 kg. Sono inclusi un sistema di estensione VESA e clip per il passaggio dei cavi. Rifinitura in colore grigio metallizzato.

68 | Screen support "Zoom"
An ideal solution for LCD/Plasma up to 28 inch, distinguished by its high quality design aesthetic. Featuring an integral ball joint, it offers the possibility of rotating the screens through 360°, in addition to a tilting range of 15°, up or down. Height adjustable.

DE | Tischhalterungen "Zoom"
Serie aus ergonomischen Tischhalterungen, metallisch für LCD/Plasma bis zu 28 Zoll y einem maximal Gewicht von 20 kg. Inklusive Vesa System und Clips für die Kabelhalterung. In grau-metallisch.

PO | Suporte de mesa para ecrã "Zoom"
Série de braços e suportes metálicos de mesa, para ecrãs LCD/plasma, até 28 polegadas e um máximo de 20 kg. Incluem um sistema de extensão VESA e um sistema para passar os cabos. Acabamento em cor cinzenta metalizada.

CEILING

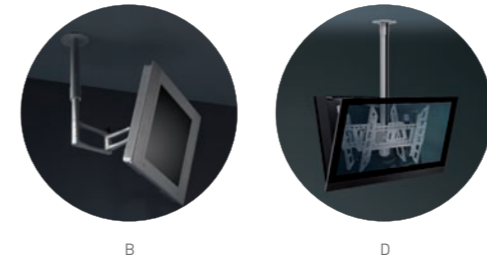

A

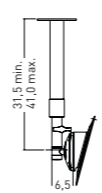

ION/C/100 31,5 / 41 6,5



C

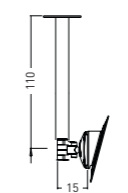

ION/C/XL 110 15



D

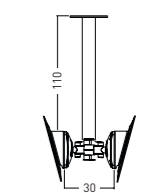

ION/C/TW/XL 110 30

E5 | Soporte LCD/Plasma de techo "Ceiling"
Serie ergonómica de brazos y soportes metálicos de fijación suspendida a techo, para pantallas de LCD / plasma hasta 28 pulgadas y un máximo de 80 kg. Incluyen sistema de extensión VESA y clip pasacables. Acabado en color gris metalizado.

FR | Support plafond pour écran "Ceiling"
Supports plafond sur platine pour écrans LCD/Plasma jusqu'à 28 pouces et 20 Kg. Comprend un système d'extension VESA et des goulottes pour cables électriques. Finition gris métallisé. Version XL et XXL jusqu'à 80 Kg et 65 pouces.

IT | Supporto schermo da tetto "Ceiling"
Serie di bracci e supporti metallici per fissaggio al soffitto, per schermo LCD/plasma fino a 28 pollici ed un massimo di 80 kg. Sono inclusi un sistema di estensione VESA e clip per il passaggio dei cavi. Rifinitura in colore grigio metallizzato.

68 | Ceilings brackets LCD/Plasma "Ceiling"
Ceilings brackets for LCD/Plasma screens. VESA extension for a maximum mounting 80 kg. Adjustable height.

DE | Befestigungsserie "Ceiling"
Befestigungsserie aus Standfüßen und Armen zur Befestigung an die Decke für LCD/Plasma Fernseher bis zu 28 Zoll und einem maximal Gewicht von 80 kg. Inklusive "Vesa" System und Clips zur Kabelhalterung. In grau-metallisch.

PO | Suporte de tecto para ecrã "Ceiling"
Série de braços e suportes metálicos para fixação ao tecto, para ecrãs LCD/plasma, até 28 polegadas e um máximo de 80 kg. Incluem um sistema de extensão VESA e um sistema para passar os cabos. Acabamento em cor cinzenta metalizada.

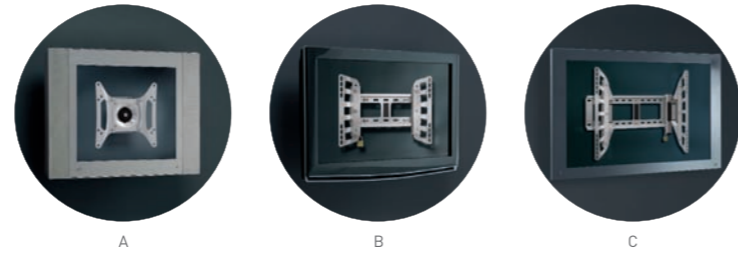

322

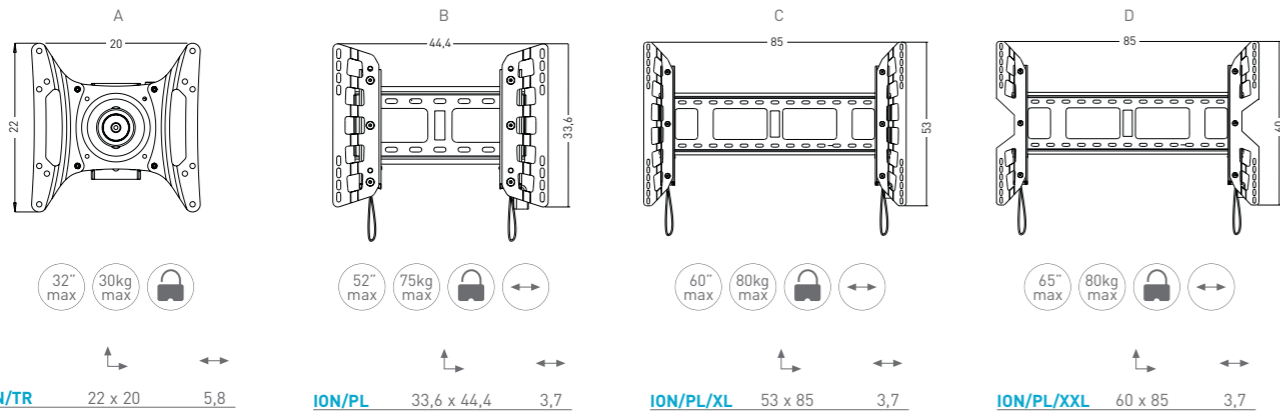

ES | Soporte pantalla mural "Terra"

Serie de soportes murales metálicos para pantallas de LCD / plasma de 32 hasta 65 pulgadas y un máximo de 80 kg. Incluyen sistema de seguridad con candado. Acabado en color gris metalizado. Ideal para grandes formatos (XL y XXL).

FR | Platine murale pour écran "Terra"

Platines murales métalliques pour écrans LCD/Plasma jusqu'à 32 / 65 pouces et un maximum de 80 Kg. Comprend un système de sécurité avec cadenas. Finitions gris métallisé.

IT | Supporto schermo da parete "Terra"

Serie di supporti metallici da parete per schermi LCD/plasma a partire da 32 fino a 65 pollici ed un massimo di 80 kg. E' incluso un sistema di sicurezza con lucchetto. Rifinitura in colore grigio metallizzato. Ideale per grandi formati (XL e XXL).

GB | Wall brackets for screens "Terra"

Wall brackets for screens up to 32 / 65 inch with a maximum weight of 80 Kg. Possibility to swivel and tilt 30°. Equipped with security lock.

DE | Wandbefestigungsserie "Terra"

Wandbefestigungsserie zur Befestigung an die Decke für LCD/Plasma Fernseher bis zu 32 und 65 Zoll und einem maximalen Gewicht von 80 kg. Inklusive Sicherheitssystem mit Schloß. In grau-metallisch. Ideal für große Formate (XL und XXL).

PO | Suporte de parede para ecrã "Terra"

Série de braços e suportes de parede metálicos, para ecrãs LCD/Plasma até 32 e 65 polegadas e um máximo de 80 kg. Incluem um sistema de segurança para cadeado. Acabamento em cor cinzenta metálica. Ideal para grandes formatos (XL e XXL).

ES | Soporte para TV graduable y móvil

Soporte móvil para TV, pantallas y monitores de gran robustez, que incorpora un estante graduable en altura. Disponible en color gris y negro. Ideal para salas de formación, centros de convenciones, etc... Incluye estante.

FR | Support mobile pour télévision

Support mobile pour écrans de télévision et moniteurs très robuste, incorporant une étagère réglable en hauteur. Disponible en gris et noir. Idéal pour les salles de formation, centres de congrès, etc. .

IT | Supporto per TV regolabile e mobile

Supporto mobile per TV, attacco per monitor di grande robustezza, che comprende un'asta regolabile in altezza. Disponibile in colori grigio e nero. Ideale per sale di formazione, centro congressi, etc. Incluso lo stand.

GB | Support for adjustable and mobile TV

Mobile Stand for TV screens and monitors really robust, incorporating or adjustable height shelf. Available in grey and black. Ideal for training rooms, convention halls, etc... Shelf included.

DE | Beweglicher Untersatz f. TV

Robuster, beweglicher Untersatz für Monitore und TV, höhenverstellbar, mit Ablagemöglichkeit. Farben: Schwarz und Grau. Ideal für Schulungen und Kongresse.

PO | Suporte para TV ajustável e móvel

Suporte móvel para TV, telas de projeção e monitores, de grande robustez, que inclui uma prateleira ajustável em altura. Disponível em cor cinza ou preta. Ideal para salas de formação centros de convenções, etc... Inclui prateleira.

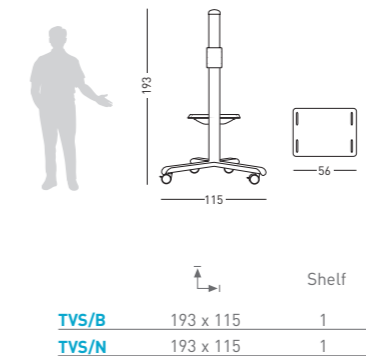

323

TROLEY

PS design



A
MG

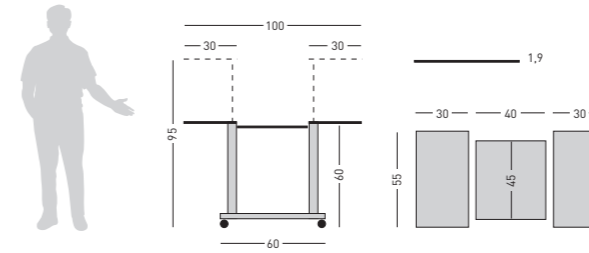

MG 60 / 95 40 x 45 1,9



325

B
MM

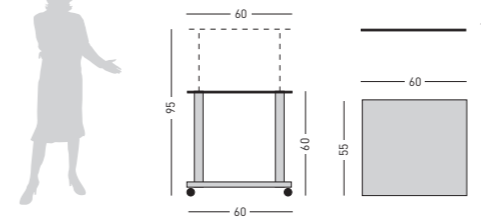

MM 60 / 95 60 x 55 1,9

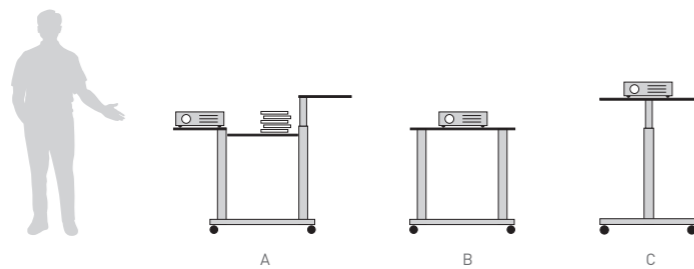

ES | Mesas de proyección

Mesa de proyección cómoda y ligera, con ruedas multidireccionales, provistas de freno las delanteras. Toda la gama de mesas tienen la estructura metálica pintada en color gris, y los tableros son de madera melaminada.

GB | Projector trolleys

With a modern design suitable for all OHPs, this functional grey metallic mobile trolley features a laminated tabletop for storage of accessories and equipment, and 4 fully circular castors (lockable front castors).

FR | Tables de rétroprojection

Table de projection légère et stable. Conception en métal gris et plateau en mélaminé. Equipée de 4 roulettes pivotantes dont 2 avec freins, qui assurent mobilité et stabilité. Plateau télescopique réglable en hauteur. Idéal pour n'importe quel type de projecteur.

DE | Projektionswagen

Dieser Projektionstisch eignet sich besonders für Vorführungen mit Overhead Projektoren. Farbe: lichtgrau. Laminierte Ablageplatten. Einfache stufenlose Höhenverstellung am Tisch für eine ergonomische Körperhaltung während der Arbeit.

IT | Tavolini per proiettore

Tavolo per proiettori leggero e comodo con ruote con freno. Tutta la gamma dei tavolini è composta da una struttura metallica grigia ed i ripiani sono di laminato grigio. Altezza regolabile per una proiezione dalla posizione migliore possibile.

PO | Mesas de projecção

Mesa de projecção cómoda e ligeira, com rodas multireccionais, com travão nas dianteiras. Toda a gama de mesas tem a estrutura metálica pintada na cor cinzenta e as prateleiras são em melamina. As prateleiras laterais são graduáveis em altura.

C
MP

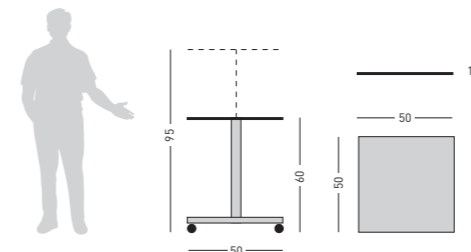

MP 60 / 95 50 x 50 1,9



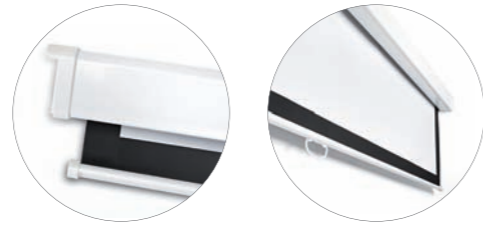

326



327

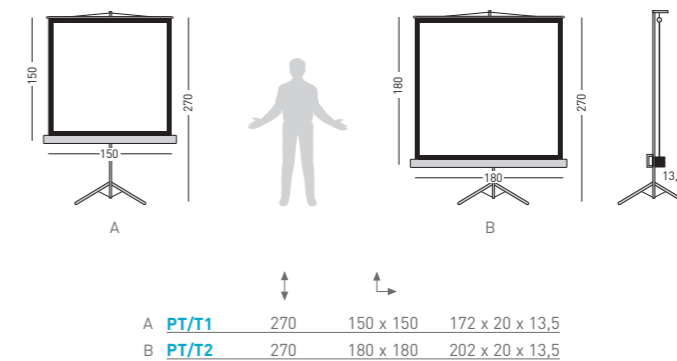
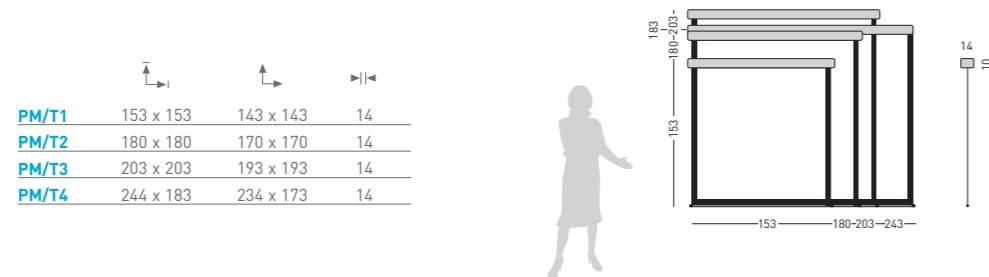

ES | Pantalla mural "Basic"

Pantalla mural de proyección, adaptable a techo y pared. La carcasa está fabricada en chapa plastificada color blanco y la tela es especial antirreflejante. La tela se puede desenrollar a la medida deseada y el enrollado es automático. Ganancia: 1,3. Tela M1.

FR | Écran de projection "Basic"

Écran de projection manuel, fixation murale et/ou plafond. Carter en tôle plastifiée blanc non réfléchissant. Grande qualité d'image, la toile blanc mat de gain 1,3 est ignifugé M1. Déroulement simple et rapide à la dimension souhaitée.

IT | Schermo a muro per proiezione "Basic"

Schermo per proiezione per soffitto o parete. La struttura è completamente bianca (in laminato) e il tessuto è anti riflesso. Il tessuto può essere srotolato fino alla misura di cui si necessita e il riavvolgimento è automatico. Gain 1,3. Tessuto M1.

ES | Pantalla con trípode "Basic"

Pantalla de proyección con trípode. La carcasa de gran diseño, está fabricada en chapa plastificada color blanco y la tela es especial antirreflejante. Posee brazo inclinable para corregir la distorsión de la imagen. Estructura plegable. Ganancia: 1,3. Tela M1.

FR | Écran de projection sur pied "Basic"

Écran de projection sur trépied avec potence télescopique et correction de parallaxe. Carter en tôle plastifiée blanc non réfléchissant. Grande qualité d'image, la toile blanc mat de gain 1,3 est ignifugé M1. Déroulement simple et rapide à la mesure souhaitée.

IT | Tripode per proiezione "Basic"

Schermo per proiezione su tripode. La cassa è fabbricata in laminato bianco e il telo è anti riflesso. Facile da installare e da usare. Lo schermo ha un braccio inclinabile per correggere la distorsione delle immagini. Struttura piegabile. Gain 1,3. Tessuto M1.

GB | Wall projector screen "Basic"

Projector screen for the ceiling and wall. The design casing is made entirely of white laminated sheet metal and the fabric is anti-glare. The fabric can be unrolled to the wished measurement and the rolling up is automatic. Gain 1,3. Fabric M1.

DE | Projektions-Leinwand "Basic"

Roll-Leinwand zur Wand- und Deckenmontage geeignet. Plastifiziertes Metall-Projektionswandgehäuse und Leinwandtuch speziell für Blendschutz. Rollmechanik für stufenloses Einstellen der Tuchhöhe und aufrollbare Projektionsfläche. M1.

PO | Tela de projecção "Basic"

Tela de projecção, adaptável ao tecto e à parede. A caixa da tela é fabricada em chapa plastificada branca e a tela é antireflexo. A tela pode-se desenrolar à medida desejada e a recolha é automática. Ganho 1,3. Tela M1.

GB | Tripod projector screen "Basic"

Tripod projector screen. The design casing is made entirely of white laminated sheet metal and the fabric is anti-glare. Easy to install and to use. The screen has an adjustable inclined bracket to correct image distortion. Foldable structure. Gain 1,3. Fabric M1.

DE | Stativ-Projektions-Leinwand "Basic"

Stativ-Projektionsleinwand. Plastifiziertes Metall-Projektionswandgehäuse und Leinwandtuch speziell für Blendschutz. Bequem tragbar, überall verwendbar. Anwinkelbarer Bügel zur Vermeidung von Lichtverzerrungen. Leuchtdichtefaktor ca 1,3. M1.

PO | Tela de projecção com tripé "Basic"

Tela de projecção com tripé. A caixa da tela é fabricada em chapa plastificada branca e a tela é antireflexo. Possui um braço inclinável para corrigir a distorção da imagem. Estrutura desmontável para ser guardada ou transportada com facilidade. Ganho 1,3. Tela M1.



	↕	↔	↔
PMM/10	150 x 150	140 x 140	14
PMM/11	171 x 128	161 x 118	14
PMM/12	203 x 153	193 x 143	14
PMM/13	244 x 183	234 x 173	19
PMM/14	300 x 300	290 x 290	19
PMM/15	300 x 400	290 x 390	19

* Mando a distancia incluido.
* Remote control included.

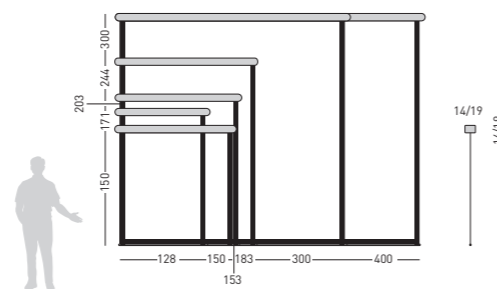

ES | Pantalla mural eléctrica

Pantalla mural de elevación automática por medio de un motor eléctrico adaptable a techo y pared. La carcasa está fabricada en aluminio y la tela es especial antirreflecente. El funcionamiento de la pantalla se acciona mediante un interruptor manual.

GB | Electrical projection screen

Wall or ceiling projection screen. Roll-up mechanism driven through an electrical motor. The design casing is made entirely of aluminium and the fabric is anti-glare. A manual switch (included) or remote controls (optional). Gain 1,3. Fabric M1.

FR | Écran de projection électrique

Écran de projection motorisé. Fixation murale ou plafond. Moteur à vitesse de rotation élevée, permettant une mise en place de l'écran très rapide. Carter en aluminium anodisé de couleur gris, anti-reflets. Interrupteur manuel (inclus). Gain 1,3 est ignifugé M1.

DE | Elektrische projektions-Leinwand

Elektrische Leinwand an der Wand oder Decke montierbar. Automatische Aufrollen durch elektrischen Motor. Aluminium Projektionswandgehäuse und Leinwandtuch speziell für Blendschutz. Geeignet für alle Arten von Projektionen. Leuchtdichtefactor ca 1,3. M1.

IT | Schermo a muro per proiezione elettrico

Schermo per proiezione per soffitto o parete. Il meccanismo di avvolgimento avviene mediante un comando elettronico. La cassa è in alluminio ed il telo è anti riflesso. Un interruttore manuale aziona il telo e lo posiziona all'altezza desiderata. Gain 1,3. M1.

PO | Tela de projecção eléctrica

Tela de projecção de elevação automática por meio de um motor eléctrico, adaptável ao tecto e à parede. A caixa da tela é fabricada em alumínio e a tela é antirreflexo. O funcionamento da tela é accionado mediante um interruptor manual (incluído). Ganho 1,3.



	↕	↔	↔
A PPB/1	117 x 156	180	12 x 16
B PPB/2	147 x 196	220	12 x 16

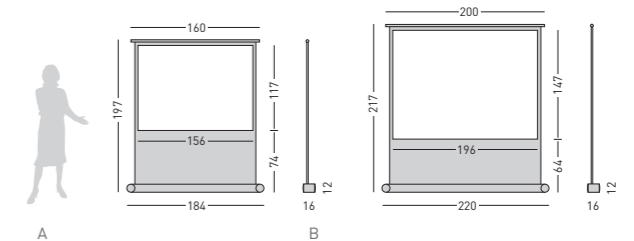

ES | Pantalla de proyección de pie

Pantalla de proyección enrollable de tela mate anti-reflecente, con sistema de sujeción mediante tijera posterior. Conjunto dotado de ruedas para su fácil transporte.

GB | Ground based projection screen

Ground based projection screen with pantograph spring M1 matt white fabric with a black mask on the bottom. Including castors for an easy move.

FR | Ecran de projection à poser au sol

Ecran de projection escamotable par système de pantographe. Toile blanc mat et M1 avec masque noir en partie basse. L'ensemble est doté de roulettes pour faciliter le transport.

DE | Projektionsbildwand zum einrollen

Projektionsbildwand zum einrollen, Fläche auf Folienbasis, mattweiß. Mit Befestigungssystem. Gestell mit Rädern für den leichten Transport.

IT | Schermo di proiezione da terra

Schermo per proiezione avvolgibile in tessuto opaco anti-riflesso, con sistema di sospensione mediante incastro sul retro. Set dotato di ruote per facilitarne il trasporto.

PO | Tela de projecção de pé

Tela de projecção mate anti-reflexo, com sistema de abertura através de um braço traseiro. Conjunto dotado de rodas, para um transporte mais fácil.

LAPCAB



A PC's

	(x,y)	(z)	?	Ud.
LAPCAB/P/10	61 x 70	111	PC	10
LAPCAB/P/16	101 x 70	111	PC	16
LAPCAB/P/20	101 x 70	111	PC	20



B PC's

	(x,y)	(z)	?	Ud.
LAPCAB/H/16	86 x 70	121	PC	16
LAPCAB/H/32	130 x 70	121	PC	20



C notebook

	(x,y)	(z)	?	Ud.
LAPCAB/N/20	61,6 x 70	110	NoteB	20
LAPCAB/N/32	101 x 70	110	NoteB	32



D tablet

	(x,y)	(z)	?	Ud.
LAPCAB/T/32	70 x 62	110	Tab	32



330

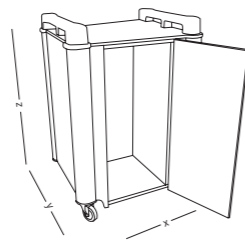

A	(x,y)	(z)	?	Ud.
LAPCAB/P/10	61 x 70	111	PC	10
LAPCAB/P/16	101 x 70	111	PC	16
LAPCAB/P/20	101 x 70	111	PC	20

B	(x,y)	(z)	?	Ud.
LAPCAB/H/16	86 x 70	121	PC	16
LAPCAB/H/32	130 x 70	121	PC	20

C	(x,y)	(z)	?	Ud.
LAPCAB/N/20	61,6 x 70	110	NoteB	20
LAPCAB/N/32	101 x 70	110	NoteB	32

D	(x,y)	(z)	?	Ud.
LAPCAB/T/32	70 x 62	110	Tab	32

ES | Armario cabinet porta PC's móvil
Gama de armarios cabinet móviles con ruedas para carga de PC's, Notebooks y Tablets. Diferentes capacidades según formato. Todos los modelos están provistos de cerradura con llave.

FR | Chariots de recharge pour ordinateurs
Armoire mobiles série Cabinet avec roulettes pour chargement de PC, Notebooks et tablettes. Capacités différentes, selon la taille. Tous les modèles sont équipés de serrure à clé.

IT | Contenitore porta PC mobile
Gamma di contenitori mobili con ruote per contenere PC, Notebooks e Tablets. Capacità differenti per differenti formati. Tutti i modelli sono provvisti di serratura con chiave.

GB | Mobile cabinet PC's carrier
Mobile storage cabinets series with wheels for loading PC's, Notebooks and Tablets. Different capacities by size. All models are with a key lock.

DE | Auswahl von beweglichen Unterschrank
Auswahl von beweglichen Unterschrank für PC's, Notebooks und Tablets. Verschiedene Größen lieferbar. Alle Modelle sind Abschliessbar.

PO | Armario cabinet porta PC's móvil
Gama de armarios cabinet móviles con ruedas para carga de PC's, Notebooks y Tablets. Diferentes capacidades según formato. Todos los modelos están provistos de cerradura con llave.

331



NEW

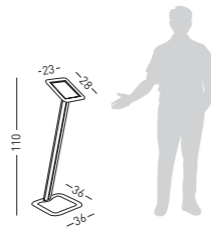

	TAB	↑	Base
A	600/IP/NG	23 x 28	110
B	600/IP/BL	23 x 28	110

ES | Atril y soporte porta iPad

Gama de atriles y soportes de aluminio porta iPad. Disponible en versión de pié y mural. Ideal para comercios, showrooms, ferias y convenciones. El sistema incorpora dispositivo de seguridad antirrobo.

FR | Chevalet et supports pour iPad

Gamme de chevalet et supports en aluminium tubulaire pour iPad. Disponible en version murale et sur pie. Idéal pour magasins, salles d'exposition, salons et congrès. Le système comprend un antivol.

IT | Aggancio e supporto porta iPad

Gamma di agganci e supporti di alluminio porta iPad. Disponibile in versione da terra e da parete. Ideale per commercio, showrooms, fiere e conferenze. Il sistema comprende un dispositivo di sicurezza anti-furto.

GB | Lectern and iPad holder support

Range of lectern and display in aluminium tube for iPad holder. Available in wall and floor versions. Ideal for shops, showrooms, exhibitions and conventions. The system incorporates anti-theft device.

DE | Pulte und Halter f. iPad

Auswahl von Pulten und Halterungen aus Aluminium für iPad's, als Ständer und für die Wand erhältlich. Ideal für Ausstellungsräume, Messen, Kongresse. Mit integriertem Diebstahlsschutz.

PO | Suporte para iPad

Gama de suportes em alumínio para iPad. Disponível na versão de chão e de parede. Ideal para lojas, showrooms, feiras e convenções. O sistema inclui um dispositivo anti-roubo.



NEW

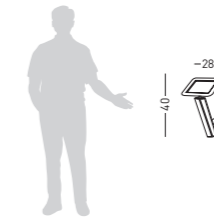

	TAB	↑
A	600/IM/NG	23 x 28
B	600/IM/BL	23 x 28

ES | Atril y soporte porta iPad

Gama de Atriles y soportes de aluminio porta iPad. Disponible en versión de pié y mural. Ideal para comercios, showrooms, ferias y convenciones. El sistema incorpora dispositivo de seguridad antirrobo.

FR | Chevalet et supports pour iPad

Gamme de chevalet et supports en aluminium tubulaire pour iPad. Disponible en version murale et sur pie. Idéal pour magasins, salles d'exposition, salons et congrès. Le système comprend un antivol.

IT | Aggancio e supporto porta iPad

Gamma di agganci e supporti di alluminio porta iPad. Disponibile in versione da terra e da parete. Ideale per commercio, showrooms, fiere e conferenze. Il sistema comprende un dispositivo di sicurezza anti-furto.

GB | Lectern and iPad holder support

Range of lectern and display in aluminium tube for iPad holder. Available in wall and floor versions. Ideal for shops, showrooms, exhibitions and conventions. The system incorporates anti-theft device.

DE | Pulte und Halter f. iPad

Auswahl von Pulten und Halterungen aus Aluminium für iPad's, als Ständer und für die Wand erhältlich. Ideal für Ausstellungsräume, Messen, Kongresse. Mit integriertem Diebstahlsschutz.

PO | Suporte para iPad

Gama de suportes em alumínio para iPad. Disponível na versão de chão e de parede. Ideal para lojas, showrooms, feiras e convenções. O sistema inclui um dispositivo anti-roubo.