

04 Expoplan

ES| Sistemas de exposición
GB| Display systems
FR| Systèmes d'exposition
DE| Ausstellungssysteme
IT| Sistemi espositivi
PO| Sistemas de exposição



es| Sistemas de exposición
Familia de productos dedicada a cubrir todas las necesidades dentro del mundo de la exposición, y cubre desde elementos auxiliares para la gestión y comunicación en espacios o eventos, hasta una gran gama de soportes para insertar en ellos, de manera comunicativa y eficaz, la información deseada. Expositores de folletos, vitrinas expositoras, postes para guiado peatonal, cajas de luz, portapósters y portafolletos, son los elementos necesarios para una buena comunicación en cualquier espacio público o privado.



fr| Systèmes d'exposition
Voici une famille de produit qui va couvrir tous les besoins du monde de l'exposition, avec des éléments auxiliaire pour la gestion d'espaces ou d'événements. Valorisez votre marque, vos produits, votre message sur nos supports modernes et au design innovant. Vitrines, poteaux guide files, affichage lumineux, cadre pour poster et systèmes d'affichage par câbles... sont indispensables pour une communication actuelle et moderne dans les centres commerciaux, entreprises, musées...



it| Sistemi espositivi
EXPOPLAN è una famiglia di prodotti diretta a coprire tutte le esigenze per il settore dei display. Permette di realizzare ogni tipo di comunicazione efficiente grazie alla varietà dei supporti. Porta depliant, vetrinette, colonnine segnapercorso, cornici a scatto, porta poster e porta depliant sono elementi per una comunicazione moderna per aree private o pubbliche come centri commerciali, cantieri, musei, aziende in genere.



en| Display systems
EXPOPLAN is the product family directed to cover all the needs of the display field. It allows to realize any kinds of efficient communication thanks to the large varieties of supports. Display leaflets, display show-cases, queue guides, snap frames, poster holders and brochure holders are the elements of a good and modern communication for any public or private area such as commercial canters, museums, companies...



de| Ausstellungssysteme
EXPOPLAN ist die Produktfamilie, die alle Notwendigkeiten innerhalb der Ausstellungswelt lösen kann. Sie bietet sowohl die Elementen für das Management und Kommunikation in Privat oder öffentlichen Räumen, als auch eine vielfältige Produktpalette für das Display von der gewünschten Information an. Prospektständer, Absperrständer, Prospektregale, Leuchtkasten und Prospektsteller sind die grundlegenden Elemente für eine gute Kommunikation in allem öffentlichen oder privaten Räume.



po| Sistemas de exposição
EXPOPLAN é a família de produtos dedicada a cobrir todas as necessidades dentro do mundo da exposição e cobre desde elementos auxiliares para a gestão e comunicação em espaços ou eventos, até uma grande gama de suportes para inserir neles, de uma forma comunicativa e eficaz, a informação desejada. Expositores de folhetos, vitrines expositoras, postes para limitar zonas e pessoas, caixas de luz, porta póster e porta folhetos, são os elementos necessários para uma boa comunicação.



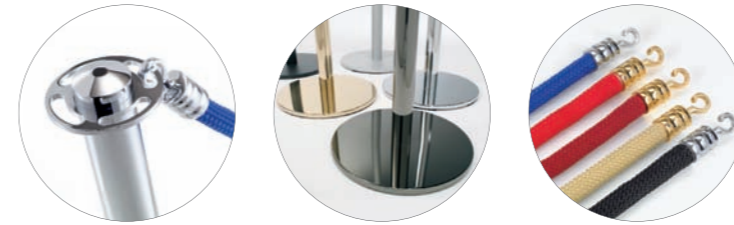

126

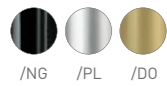

	A	↑	↔	∅
805/NG	100	30	5	
805/PL	100	30	5	
805/DO	100	30	5	

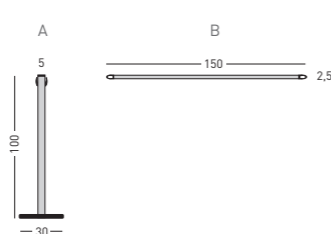

	B	↑	↔
805/C/NG	2,5	150	
805/C/AZ	2,5	150	
805/C/RJ	2,5	150	
805/C/BD	2,5	150	
805/C/CR	2,5	150	
* 806/C/BL	2,5	150	
* 806/C/NG	2,5	150	

ES | Postes separadores de cordón

Poste separador de aluminio con base metálica negra, resistente y de gran estabilidad, para separaciones de áreas y guiado peatonal. Disponible en 3 colores: negro, plata y oro. Cordón de 1,5 m, disponible en 2 trenzados distintos.

FR | Poteaux guides

Poteau stable en aluminium, socle métallique noir, très résistant. S'intègre à tous les espaces d'accueil, délimitation des zones et flux piétonnier. Disponibles en 3 couleurs: noir, argent et or. Cordes de 1,5 m, disponibles en deux types de tresses.

IT | Colonnina

Colonnina in alluminio con base metallica nera molto stabile per separare aree e formare file organizzate. Disponibile in 3 colori: silver, oro, nero. Il cordone da mt. 1,5 è disponibile in diversi stili (grosso o sottile a treccia).

GB | Queue guides

Aluminium queue guide with very stable black metallic base for separating different areas and forming organized queues. Available in 3 colours: black, silver and gold. 1,5 meter rope available in different styles (thick or thin braid).

DE | Absperssysteme

Exklusive und elegante Absperssysteme. Stand Aluminium versilbert oder vergoldet. Hohe Standsicherheit durch schwarze Fußplatte. Für Informationen und als Wegweiser, wo Publikum geleitet und gelenkt werden soll. 1,5 m.

PO | Poste separador em aluminio

Poste separador em alumínio com base metálica preta, resistente e de grande estabilidade, para a separação de áreas e limitação de passagem. Disponível em 3 cores: preto, prata e dourado. Cordão com 1,5 m. disponível em dois tipos de entrançado.

127



	A	↑	↔	∅
804/CR	95	34	5	
804/DO	95	34	5	
804/GR	95	34	5	
804/PL	95	34	5	
804/NG	95	34	5	

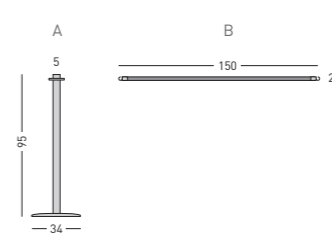

	B	↑	↔
804/C/NG	2,5	150	
804/C/AZ	2,5	150	
804/C/RJ	2,5	150	
804/C/BD	2,5	150	
804/C/CR	2,5	150	
* 804/CT/BL	2,5	150	
* 804/CT/NG	2,5	150	

ES | Postes separadores de cordón "Luxe"

Poste separador de tubo y base de latón, resistente y de gran estabilidad, para separaciones de áreas y guiado peatonal. Disponible en 5 colores. Cordón de 1,5 m, disponible en 2 trenzados distintos.

FR | Poteaux guide files "Luxe"

Poteau avec socle en laiton, très stable et résistant. S'intègre à tous les espaces d'accueil, délimitation des zones et flux des piétons. Disponibles en 5 couleurs. Cordes de 1,5 m, disponibles en deux types de tresses différents.

IT | Colonnina "Luxe"

Colonnina molto stabile con base in ottone per separare aree e formare file organizzate. Disponibile in 5 colori: silver ed oro. Il cordone da mt. 1,5 è disponibile in diversi stili (grosso o sottile a treccia).

GB | Queue guides "Luxe"

Queue guide with a very stable brass base for separating different areas and forming organized queues. Available in 5 colours. 1,5 meter rope available in different styles (thick or thin braid).

DE | Absperreil "Luxe"

Sowohl die Ständer Design (mit Fuß aus Messing) als auch die Auswahl an Kordeln dieses Systems bilden einen wesentlichen Bestandteil der Organisation, der Informanten und des Schutzes in Museen, Flughäfen, Theater, Kinos, Kongresse, etc. 1,5 m. Samtkordel.

PO | Poste separador "Luxe"

Poste separador com tubo e base em latão, resistente e de grande estabilidade, para a separação de áreas e limitação de passagem. Disponível em 5 cores. Cordão com 1,5 m. disponível em dois tipos de entrançado.



128



A	300	95	34	7
808/...				
B	300	50	34	7
809/...				

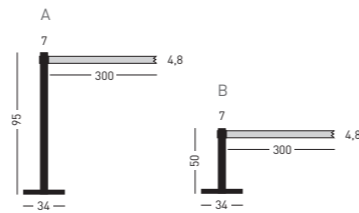

ES | Postes de cinta extensible retráctil
Poste separador metálico de 95 y 50 cm de alto, para separaciones de áreas y guiado peatonal. Disponibles en varios colores tanto de poste como de cinta, disponible en 3 m. de largo. El cabezal del poste incorpora 3 vías de enganche.

FR | Poteau guide-files à sangle rétractable
Poteau guide-file de 50 ou 95 cm. de haut pour délimitation d'espaces et guidage des usagers. Poteaux et sangles disponibles dans différentes couleurs. Sangles de 3 m. Un départ de sangle et 3 arrivées permettant de nombreuses configurations.

IT | Colonnina metallica con nastro retraibile
Colonnina separatore metallico alto 95 o 50 cm, per separare aree e passaggi pedonali. Disponibilità di vari colori sia per Colonnina che per nastro divisore (lungo 3 m.). La parte superiore del Colonnina ammette 3 possibilità d'aggancio.

GB | Retractable queue guides
50 or 95 cm height barrier-post for areas delimitation and users guidance. Posts and tapes available in different colors. 3 m. tapes. 1 tape starting slot and 3 ending slots for multiple layouts.

DE | Metallischer Absperrpfosten
Metallischer Absperrpfosten 95 cm oder 50 cm hoch. Diese können als Begrenzung für sämtliche Bereiche wie zum Beispiel Fußgängerbereiche, Parkplätze, Fahrbahnen und Sicherheitszonen genutzt werden.

PO | Poste metálico com cinta extensível
Poste separador metálico com 95 e 50 cm. de altura, para separação de áreas e limitação de passagem. Disponível em várias cores, tanto de poste como de cinta, que se encontra disponível com 3 m. de comprimento. O cabeçal permite a chegada de 3 cintas.

A
painted color

/NG	/GR	/RJ	/AM	/AZ	/VD	/PL	/OR	/PER
ES - Negro	- Gris	- Rojo	- Amarillo	- Azul	- Verde	- Plata	- Oro	- Personalizado
GB - Black	- Grey	- Red	- Yellow	- Blue	- Green	- Silver	- Gold	- Personalize
FR - Noir	- Gris	- Rouge	- Jaune	- Bleu	- Vert	- Or	- Or	- Personnalisée
DE - Schwarz	- Grau	- Rot	- Gelb	- Blau	- Grün	- Gold	- Gold	- Personalisierte
IT - Nero	- Grigio	- Rosso	- Giallo	- Blu	- Verde	- Argento	- Oro	- Personalizzato
PO - Preto	- Cinzento	- Vermelho	- Amarelo	- Azul	- Verde	- Prata	- Ouro	- Personalizado

B
cinta

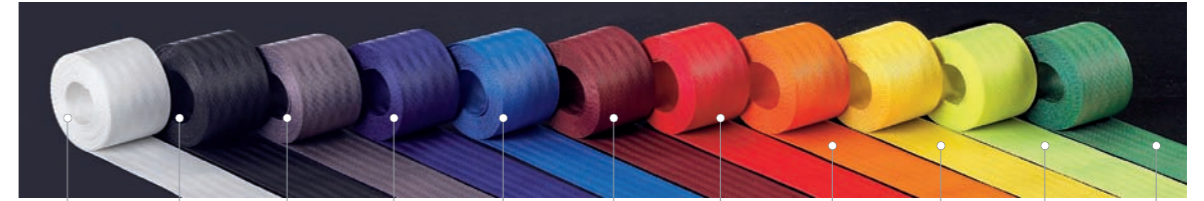

/BL	/NG	/GR	/AZO	/AZ	/BD	/RJ	/NJ	/AM	/FL	/VD
ES - Blanco	- Negro	- Gris	- Azul osc.	- Azul	- Burdeos	- Rojo	- Naranja	- Amarillo	- Fluorescente	- Verde
GB - White	- Black	- Grey	- Dark blue	- Blue	- Cardinal	- Red	- Orange	- Yellow	- Shiny	- Green
FR - Blanc	- Noir	- Gris	- Bleu foncé	- Bleu	- Bordeaux	- Rouge	- Orange	- Jaune	- Fluorescent	- Vert
DE - Weiß	- Schwarz	- Grau	- Dunkelblau	- Blau	- Bordeaux	- Rot	- Orange	- Gelb	- Glänzend	- Grün
IT - Bianco	- Preto	- Grigio	- Blu scuro	- Blu	- Cardinale	- Rosso	- Arancione	- Giallo	- Lucido	- Verde
PO - Branco	- Preto	- Cinzento	- Azul escuro	- Azul	- Bordeaux	- Vermelho	- Laranja	- Amarelo	- Fluorescente	- Verde

129

C
print



D
carro postes



808/CA 162,5 x 80,5 109

E
poste final



808/F/LC	95	34	7
808/F/M	95	34	7

* Poste final (sin cinta)
* Final queue (without webbing)

F
porta carteles



800/PP 30 x 21

G
terminal mural



800/TP 7 x 1



130



	300		
A	↑↓	↔	∅
808/...	95	34	7
	300		
B	↑↓	↔	∅
809/...	50	34	7

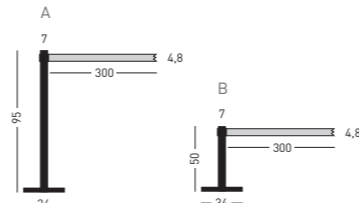

ES | Postes de cinta extensible retráctil

Poste separador metálico de 95 y 50 cm de alto, para separaciones de áreas y guiado peatonal. Disponibles en varios colores tanto de poste como de cinta, disponible en 3 y 3,7 m. de largo. El cabezal del poste incorpora 3 vías de enganche.

FR | Poteau guide-files à sangle rétractable

Poteau guide-file de 50 ou 95 cm. de haut pour délimitation d'espaces et guidage des usagers. Poteaux et sangles disponibles dans différentes couleurs. Sangles de 3 ou 3,7 m. Un départ de sangle et 3 arrivées permettant de nombreuses configurations.

IT | Colonnina metallica con nastro retraibile

Colonnina separatore metallico alto 95 o 50 cm, per separare aree e passaggi pedonali. Disponibilità di vari colori sia per Colonnina che per nastro divisore (lungo 3 o 3,7 m.). La parte superiore del Colonnina ammette 3 possibilità d'aggancio.

GB | Retractable queue guides

50 or 95 cm height barrier-post for areas delimitation and users guidance. Posts and tapes available in different colors. 3 or 3,7 m. tapes. 1 tape starting slot and 3 ending slots for multiple layouts.

DE | Metallischer Absperrpfosten

Metallischer Absperrpfosten 95 cm oder 50 cm hoch. Diese können als Begrenzung für sämtliche Bereiche wie zum Beispiel Fußgängerbereiche, Parkplätze, Fahrbahnen und Sicherheitszonen genutzt werden.

PO | Poste metálico com cinta extensível

Poste separador metálico com 95 e 50 cm. de altura, para separação de áreas e limitação de passagem. Disponível em várias cores, tanto de poste como de cinta, que se encontra disponível com 3 e 3,7 m. de comprimento. O cabeçal permite a chegada de 3 cintas.

131

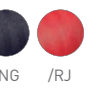

	↑↓	↔	∅
803/E2/NG	95	30	7
803/E2/RJ	95	30	7

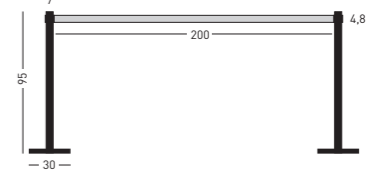

ES | 2 postes metálicos "eco" cinta extensible

Caja de 2 postes separadores metálicos de 95 cm de alto, para separaciones de áreas y guiado peatonal. Poste de color negro y cinta retráctil de 2 m. disponible en rojo y negro.

FR | Lot de 2 poteaux guide-file "éco"

Poteau guide-file éco 95 cm. de haut pour délimitation d'espaces et guidage des usagers. Poteaux noirs, sangle rouge ou noire. Un départ de sangle et 3 arrivées permettant différentes configurations.

IT | Scatola con 2 pali metallici "eco"

Colonnina separatore metallico alto 95 cm, per separare aree e passaggi pedonali. Disponibilità di colori nero per Colonnina che per nastro divisore (lungo 2 m.). La parte superiore del Colonnina ammette 3 possibilità d'aggancio.

GB | Set of 2 barrier-posts "eco"

Barrier-post eco 95 cm for areas delimitation and users guidance. Black posts, tape available in red or black. One starting slot and 3 ending slots for multiple layouts.

DE | Set mit zwei Absperrpfoste "eco"

Metallischer Absperrpfosten 95 cm hoch. Diese können als Begrenzung für sämtliche Bereiche wie zum Beispiel Fußgängerbereiche, Parkplätze, Fahrbahnen und Sicherheitszonen genutzt werden. Absperrseil in den Längen 2 m erhältlich.

PO | 2 postes metálicos "eco" cinta extensível

Caixa com 2 postes separadores metálicos com 95 cm. de altura, para separação de áreas e limitação de passagem. Poste de cor preta e cinta extensível de 2 m., disponível em negro e vermelho. O cabeçal do poste permite a chegada de 3 cintas.



132



	↑	↔	∅
808/X/PL	95	34	7
808/X/NG	95	34	7
808/X/RJ	95	34	7

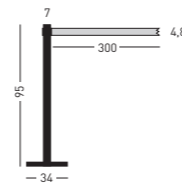

ES | Postes "Axial" cinta extensible retráctil
Poste separador metálico Axial de 95 cm de alto, para separaciones de áreas y guiado peatonal. Disponibles en negro, rojo y plata y 11 colores de cinta retráctil 3 m. Su base en aspa, permite ser apilados para su almacenaje.

FR | Poteau guide-file "Axial"
Poteau guide-file en métal de 95 cm. Poteaux et sangles 3 m. Un départ et 3 arrivées permettant différentes configurations. Base en forme de croix qui permet de les empiler pour un rangement et un déplacement plus facile.

IT | Colonnina "Axial" metallico
Colonnina separatore metallico Axial alto 95 cm, per separare aree e passaggi pedonali. Disponibile nei colori nero, rosso e argento. Cintura retrattile lunga 3 m. disponibile in 11 colori. La sua base ad aspo permette l'impilazione per poter essere riposto.

GB | Barrier-post "Axial"
Metallic barrier-post 95 cm. Post and tapes 3m. Different colors available. One starting slot and 3 ending slots for multiple layouts. Cross shaped base for an easier moving and stocking.

DE | Absperpfosten "Axial"
Absperpfosten "Axial" metallic, 95 cm hoch. Diese können als Begrenzung für sämtliche Bereiche wie zum Beispiel Fußgängerbereiche, Parkplätze, Fahrbahnen und Sicherheitszonen genutzt werden. Vor allem zur Lagerhaltung geeignet.

PO | Poste metálico "Axial"
Poste separador metálico Axial com 95 cm. de altura. Disponível em preto, vermelho e prata, e a cinta está disponível em 11 cores e 3 m. de comprimento. A base é em forma de cruz, que permite uma armazenagem num espaço mais reduzido.

133

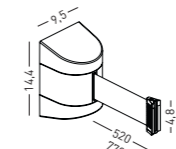
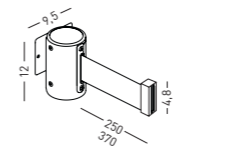
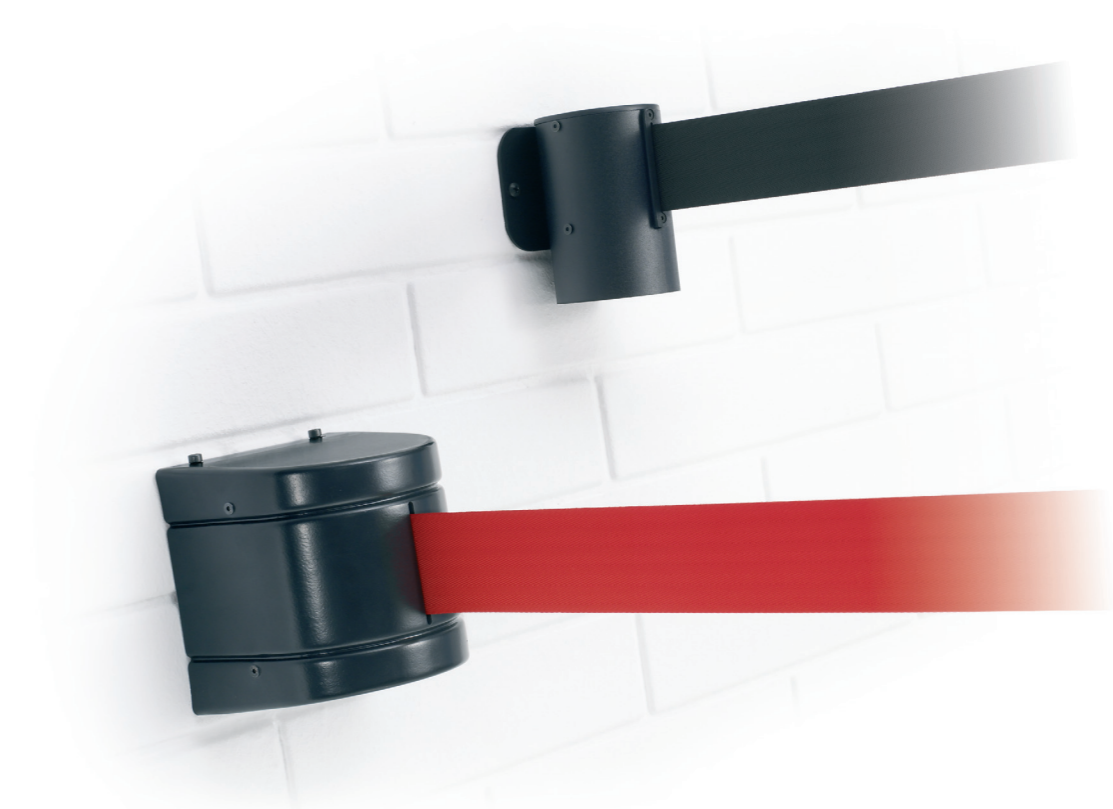

	↑	↔
800/23	4,8	250
800/37	4,8	350

	↑	↔
800/52	4,8	500
800/77	4,8	700

A	↑
800/TP	7 x 1

ES | Cinta extensible retráctil mural
Elemento mural de cinta extensible retráctil, permite de manera rápida y segura aislar provisionalmente áreas o zonas de paso, y cerrar puertas o zonas determinadas. Disponible en 2 longitudes; 2,5 m., 3,7 m., 5,2 m. y 7,7 m.

FR | Sangle retractable murale
Sangle murale rétractable avec système d'autofreinage afin qu'elle ne se rétracte pas brusquement en cas de décrochage. Délimitation efficace et rapide de tout type de surfaces. Disponible en deux longueurs: 2,5 m., 3,7 m., 5,2 m. et 7,7 mètres.

IT | Elemento murale retraibile
Elemento murale retraibile ad uso rapido e facile per chiudere spazi temporaneamente. Disponibile con nastro in 2 lunghezze: 2,5 mt.; 3,7 mt.; 5,2 mt.; 7,7 mt.

GB | Webbing felt (for wall)
Wall adjustable barrier belt for quick and easy use to close off areas temporarily. Available in 2 lengths; 2,5 m., 3,7 m., 5,2 m. y 7,7 metres.

DE | Federgurtband
Die perfekte kurzfristige Absperung an Rolltreppen, Treppen und Zugängen und zur Wegweisung in Flughäfen, Fabrikbereichen, Banken, Empfangshallen, Museen, Ausstellungen, etc... Maße Gurtband: 2,5 m., 3,7 m., 5,2 m. und 7,7 m.

PO | Elemento de parede retráctil
Elemento de parede com cinta extensível retráctil. Permite de uma forma rápida e segura separar áreas ou zonas de passagem, e fechar portas ou zonas determinadas. Disponível em 2 comprimentos: 2,5 m., 3,7 m., 5,2 m. e 7,7 m.



134



	↑	↔	∅
A 802/IN/RJ	95	34	7
B 802/IN/AM	95	34	7

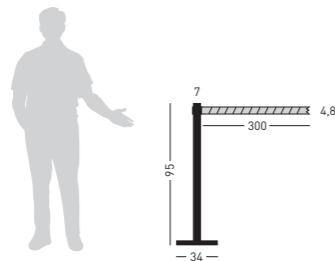

	↑	↔
C 800/IN/RJ	4,8	300
D 800/IN/AM	4,8	300

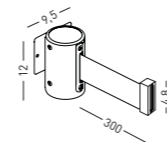

ES | Postes metálico para exterior

Poste separador metálico de 95 cm de alto, para separaciones de áreas y guiado peatonal. Disponibles en varios colores tanto de poste como de cinta, disponible en 3,5 m. de largo. El cabezal del poste incorpora 3 vías de enganche.

FR | Poteaux industriels pour l'extérieur

Guide file en métallique de 95 cm. de haut pour délimitation d'espaces et guidage des usagers. Poteaux et sangles disponibles en plusieurs couleurs et en départ mural Sangles de 3,5 m.

IT | Palo industriale di plastica

Colonnina separatore di metallo alto 95 cm, per separare aree e passaggi pedonali. Disponibilità di vari colori sia per Colonnina che per nastro divisore (lungo 3,5 m.). La parte superiore del Colonnina ammette 3 possibilità d'aggancio.

GB | Barrier post for the outside

Metallic queue guides for area delimitation and user guidance. Post and tapes available in different colors. 3,5 M tape. Wall start available.

DE | Industrie-Absperrpfosten

Metallischer Industrie-Absperrpfosten 95 cm hoch. Diese können als Begrenzung für sämtliche Bereiche wie zum Beispiel Fußgängerbereiche, Parkplätze, Fahrbahnen und Sicherheitszonen genutzt werden. Absperrseil in den Längen 3,5 m. erhältlich.

PO | Poste industrial do plástico com cinta

Poste separador metálico com 95 cm. de altura, para separação de áreas e limitação de passagem. Disponível em várias cores, tanto de poste como de cinta, disponível com 3,5 m. de comprimento. O cabeçal do poste permite a chegada de 3 cintas.

135



	↑	↔	∅
A 807/RJ	100	30	2,5
B 807/AM	100	30	2,5

	↑	↔
C 807/RB/5	3	500
C 807/RB/25	3	2.500
D 807/AN/5	3	500
D 807/AN/25	3	2.500

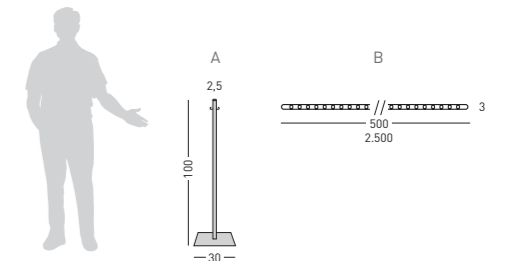

ES | Postes metálicos para exterior

Poste separador de hierro lacado, resistente y de gran estabilidad, ideal para separaciones de áreas públicas y privadas en el exterior. Disponible en 2 colores: Rojo y amarillo. Cadena de plástico de doble color (rojo/blanco y amarillo/negro).

FR | Poteaux d'extérieur

Poteau en fer, résistant et très stable pour délimiter des espaces et orienter. Coloris: Rouge et jaune. Chaîne à maillons combinés: rouge/blanc ou jaune/noir. Longueur 5 m ou 25 m.

IT | Colonnina di ferro

Colonnina metallica in ferro con base molto stabile per separare aree e formare file organizzate; disponibile in 2 colori: giallo e rosso. La catena in plastica è prodotta in colori combinati rosso/bianco o giallo/nero.

GB | Outdoor metallic queue guides

Iron metallic queue guides with a very stable base for separating different areas. Available in 2 colours: Red and yellow. The plastic chain comes in colour combinations red/white or yellow/black.

DE | Sperrpfosten für Aussen

Sperrpfosten aus Eisen. Handlich, leicht und standfest. Für schnelle, zeitweise Absperrung. Farben: Rot und Gelb. Absperrketten aus Kunststoff, wetterfest. Farbwechsel (Rot/Weiß und Gelb/Schwarz). Länge 5 m. oder 25 m-Ware.

PO | Postes separadores metálicos exterior

Poste separador em ferro, resistente e de grande estabilidade. Ideal para separação de áreas públicas e privadas no exterior. Disponível em 2 cores: Vermelho e Amarelo. Corrente de plástico de dupla cor (vermelho/branco ou amarelo/preto).



136



NEW

137



NEW

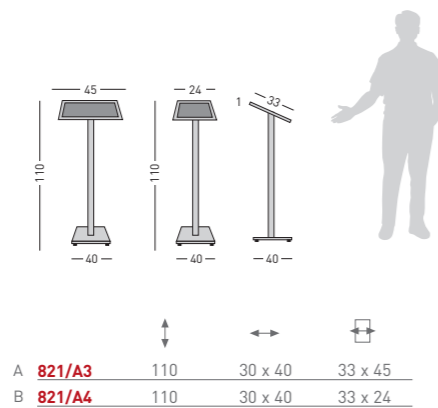

ES | Atril de marco abatible

Atril expositor de aluminio de marco abatible para exponer toda clase de información, catálogos, menús... El portapóster superior A4 y A3 permite adaptarse al soporte en posición vertical u horizontal.

FR | Pupitre à cadre clippant

Pupitre en aluminium à cadre clippant pour exposer tout type d'informations, catalogues, menus, etc... Le porte affiche A4 ou A3 peut se positionner horizontalement ou verticalement.

IT | Leggio con cornice a scatto

Leggio in alluminio ideale per esporre ogni tipo di informazione come listini, menù, ecc. La cornice a scatto può essere facilmente posta in verticale od orizzontale. Disponibile nei formati A3 ed A4.

GB | Snapframe lectern

Snapframe aluminium display, ideal to show all sorts of information, catalogues, menus, etc... The upper snapframe A4 and A3 allows to place it vertical or horizontal.

DE | Infoständer Klapprahmen

Ausziehbarständer aus Aluminium. Ideal für Speisekarten, Kataloge, Menüs, etc. Die obere Klapprahmen A4 und A3 können ohne Schwierigkeiten quer oder hoch gestellt werden.

PO | Expositor com aro de abrir

Expositor em alumínio com aro de abrir para expôr todo o tipo de informação: catálogos, menús, etc... O porta poster superior A4 e A3 permite adaptar-se ao suporte na posição vertical ou horizontal.

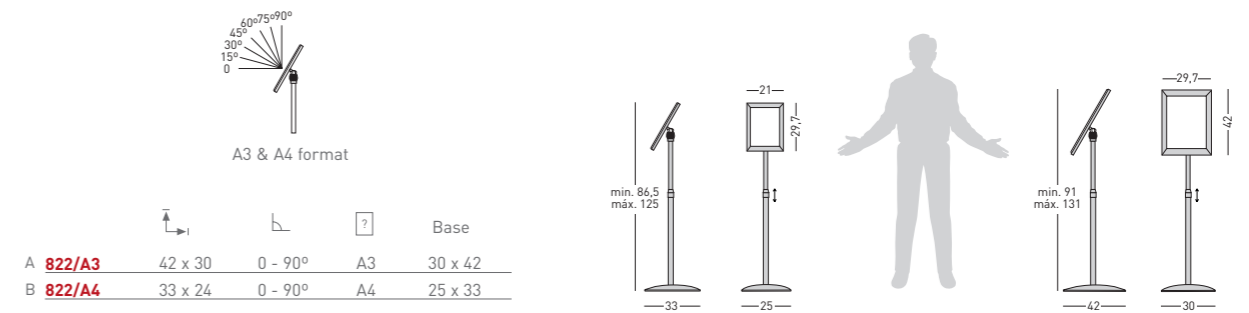

ES | Atril marco abatible y regulable

Atril expositor graduable en altura de aluminio de marco abatible para exponer toda clase de información, catálogos, menús... El portapóster superior Din A4 y Din A3 permite adaptarse al soporte en posición vertical y horizontal y es graduable en inclinación de 0° a 90°.

FR | Menuboard flexible

Pupitre exposant réglable en hauteur et en aluminium avec cadre auto clippant pour exposer toutes sortes d'informations, catalogues, menus... La partie supérieure pour documents format A4 et A3 et avec l'inclinaison verticale et horizontale réglable de 0° à 90°.

IT | Espositore da terra regolabile

Espositore da terra regolabile in altezza in alluminio con pannello inclinabile per tutti i tipi di informazione, cataloghi, menù, etc. Il portaposter superiore può essere in DinA4 o DinA3 e può essere posizionato sia verticale che orizzontale è inclinabile da 0° a 90°.

GB | Adjustable lectern with snap frame

Height adjustable lectern made of aluminium and with snap frame to hold menus, catalogues, general information... The snap frame is available in A4 and A3 format and can be positioned horizontal or vertically and with a inclination from 0° to 90°.

DE | Podest, höhenverstellbarer Infoständer

Podest, höhenverstellbarer Infoständer aus Aluminium. Ideal für Speisekarten, Kataloge oder andere Informationen. Der Klapprahmen in Format A4 oder A4 vertikal oder horizontal, lässt sich von 0 - 90 Grad neigen.

PO | Expositor ajustável

Expositor ajustável em altura de alumínio com aro de abrir para colocar todo o tipo de informação, catálogos, ementas... O porta poster DIN A4 e DIN A3 permite adaptar-se ao suporte em posição Horizontal ou Vertical, sendo que tem a inclinação ajustável entre 0° e 90°.



A	822/A3/L	420 x 297	2000 - 2200 w
B	822/A4/L	297 x 210	2000 - 2200 w

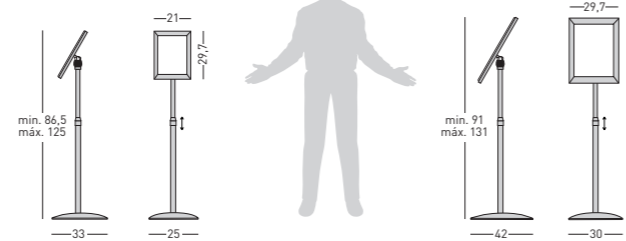

ES | Atril graduable con luz led

Atril expositor caja de luz led graduable en altura de aluminio de marco abatible para exponer toda clase de información, catálogos, menús... El portapóster superior Din A4 y Din A3 disponible en formato vertical y horizontal y es graduable en inclinación de 0° a 90°.

GB | Adjustable lectern with Led

Height adjustable lectern with Led showcase light, made of aluminium and with snap frame to hold menus, catalogues, general information...The snap frame is available in A4 and A3 format and can be positioned horizontal or vertically and with a inclination from 0° to 90°.

FR | Chevalet pour documents avec Led

Pupitre exposant avec LED réglable en hauteur et en aluminium avec cadre auto clippant pour exposer toutes sortes d'informations, catalogues, menus... La partie supérieure pour documents format A4 et A3 et avec l'inclinaison verticale et horizontale réglable de 0° à 90°.

DE | Podest, höhenverstellbarer Infoständer

Podest, höhenverstellbarer Infoständer aus Aluminium. Ideal für Speisekarten, Kataloge oder andere Informationen. Der Klapprahmen in Format A3 oder A4 vertikal oder horizontal, lässt sich von 0 - 90 Grad neigen.

IT | Espositore da terra con Led

Espositore da terra con Led regolabile in altezza in alluminio con pannello inclinabile per tutti i tipi di informazione, cataloghi, menù, etc. Il portaposter superiore può essere in DinA4 o DinA3 e può essere posizionato sia verticale che orizzontale è inclinabile da 0° a 90°.

PO | Expositor com caixa de luz LED

Expositor com caixa de luz LED ajustável em altura de alumínio com aro de abrir para colocar todo o tipo de informação, catálogos, ementas... O porta poster DIN A4 e DIN A3 permite adaptar-se ao suporte em posição Horizontal ou Vertical, sendo que tem a inclinação ajustável entre 0° e 90°.

ES | Atril portafolletos Din A4

Atril expositor graduable en altura de aluminio de marco abatible para exponer toda clase de información, catálogos, menús... El cajetín superior está disponible en formato Din A4 en posición vertical y horizontal.

GB | Adjustable lectern Din A4

Height adjustable lectern made of aluminium and with snap frame to hold menus, catalogues, general information...The snap frame is available in A4 format and can be positioned horizontal or vertical.

FR | Chevalet pour documents

Pupitre exposant réglable en hauteur et en aluminium avec cadre auto clippant pour exposer toutes sortes d'informations, catalogues, menus ... La partie supérieure pour documents format A4 en position verticale ou horizontale.

DE | Podest, höhenverstellbarer Infoständer

Podest, höhenverstellbarer Infoständer aus Aluminium. Ideal für Speisekarten, Kataloge oder andere Informationen. Der Klapprahmen in Format A3 oder A4 vertikal oder horizontal, lässt sich von 0 - 90 Grad neigen.

IT | Espositore da terra con portacataloghi

Espositore da terra regolabile in altezza in alluminio con pannello inclinabile per tutti i tipi di informazione, cataloghi, menù, etc. Il contenitore è in DinA4 o DinA3 e può essere posizionato sia verticale che orizzontale.

PO | Expositor porta folhetos

Expositor ajustável em altura de alumínio para colocar todo o tipo de informação, catálogos, ementas... O porta folhetos superior encontra-se disponível no formato DIN A4, em posição vertical ou horizontal.

	↕	↔	?	CA
823/PF	116,3	25 X 33	A4	NO
823/PF/CA	127,6	25 X 33	A4	SI



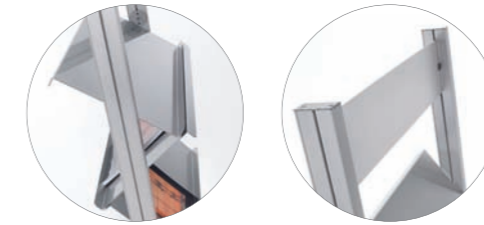

* Texto no incluido
* Sign not included

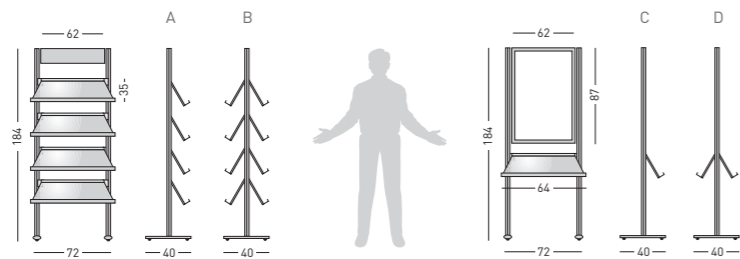

	↑	↔	□	□
A 832/4	184	72 x 40	4	
B 832/4/D	184	72 x 40	8	
C 2400/1B	184	72 x 40	1	1
D 2400/1B/D	184	72 x 40	2	2

ES | Expositores de información

Expositores compuestos por 2 perfiles elípticos verticales de aluminio en plata mate, con estantes metálicos pintados en color gris. Ideal para catálogos y revistas en formato DIN A4. Los estantes pueden situarse en uno o en ambos lados.

FR | Porte-affiches

Présentoirs composés de 2 supports elliptiques verticaux en aluminium couleur argent mat avec des étagères métalliques grises. Idéal pour catalogues et revues format A4. Les étagères sont dispo en simple ou double face.

IT | Info display in alluminio

Espositore composto da 2 profili ellittici verticali in silver. Mensole metalliche verniciate in grigio. Ideale per cataloghi e riviste in formato A4. Le mensole possono essere poste in un lato od entrambi. In cima all'espositore si trova un pannello grigio personalizzabile.

GB | Info displays

Displays made of 2 vertical elliptical aluminum supports in matt silver. Metallic shelves painted in grey. Ideal for catalogues and magazines in A4 format. The shelves can be placed on one or both sides. At the top there is a grey panel, which can be personalized.

DE | Info Displays

Stabile Konstruktion aus 2 ellipsenförmig, Alu-Profil silberfarbig eloxierten Füßen. Metalische graue Fächern, die auf eine oder beide Seiten gestellt werden können. Ideal zur Präsentation von Prospekten oder Katalogen. Für die Aufnahme von A4-Formate.

PO | Expositor de informação

Expositores compostos por 2 suportes elípticos verticais de alumínio na cor prata mate, com prateleiras metálicas pintadas na cor cinzenta. Ideal para catálogos e revistas no formato DIN A4. As prateleiras podem colocar-se de um ou dos dois lados.

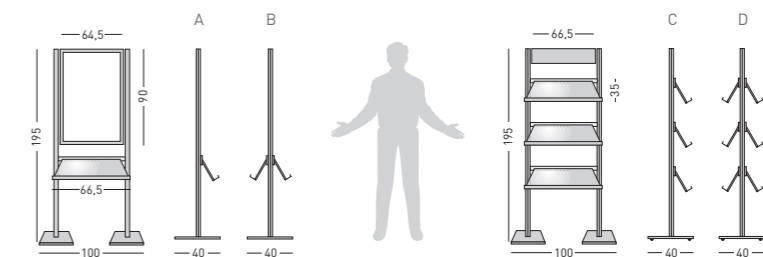

	↑	↔	□	□
A Q/400/PE	195	100 x 40	1	1
B Q/400/PE/D	195	100 x 40	2	2
C Q/400/3	195	100 x 40	3	
D Q/400/3/D	195	100 x 40	6	

ES | Expositores de información "Quadra"

Conjunto formado por un portapósters de formato DIN A1, a una o dos caras y portaestantes metálico gris sobre estructura doble de aluminio anodizado en plata mate, serie Quadra.

FR | Présentoirs "Quadra"

Présentoirs composés de 2 supports "Quadra" verticaux en aluminium couleur argent mat avec des étagères métalliques grises. Idéal pour catalogues et revues format A4. Les étagères peuvent se situer sur un ou deux côtés.

IT | Espositore per cataloghi "Quadra"

Espositore composto da n. 02 profili ellittici verticali in silver. Mensole metalliche verniciate in grigio. Ideale per cataloghi e riviste in formato A4. Le mensole possono essere poste in un lato od entrambi.

GB | Magazines displays "Quadra"

Displays made of 2 vertical elliptical aluminum supports in matt silver. Metallic shelves painted in grey. Ideal for catalogues and magazines in A4 format. The shelves can be placed on one or both sides.

DE | Prospektregale "Quadra"

Stabile Konstruktion aus 2 ellipsenförmig, Alu-Profil silberfarbig eloxierten Füßen. Metalische graue Fächern, die auf eine oder beide Seiten gestellt werden können. Ideal zur Präsentation von Prospekten oder Katalogen. Für die Aufnahme von A4-Formate.

PO | Expositor de informação "Quadra"

Expositores compostos por 2 suportes elípticos verticais de alumínio na cor prata mate, com prateleiras metálicas pintadas na cor cinzenta. Ideal para catálogos e revistas no formato A4.

SNAP FRAME



A susten.

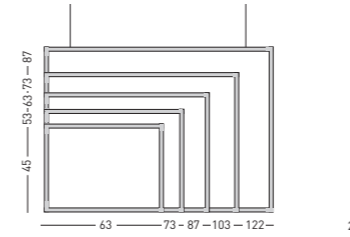

A	↕	↗	↘	?
850/I/S2	45 x 63	40 x 58	2,4	A2
850/I/S1	63 x 87	57 x 82	2,4	A1
850/I/S0	87 x 122	82 x 117	2,4	A0
850/I/S3	73 x 103	68 x 98	2,4	50x70
850/I/S4	53 x 73	48 x 68	2,4	70x100

* Doble cara
* Double side

B	↕	↗	↘	?
850/S2	45 x 63	40 x 58	2,4	A2
850/S1	63 x 87	57 x 82	2,4	A1
850/S0	87 x 122	82 x 117	2,4	A0
850/S3	73 x 103	68 x 98	2,4	50x70
850/S4	53 x 73	48 x 68	2,4	70x100



B delta

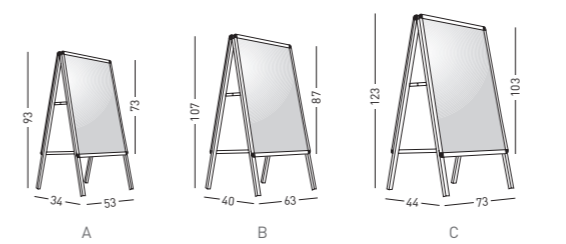

A	↕	↗	↘	?
850/I/D1	107	87 x 63	82 x 57	A1
850/I/D3	123	103 x 73	98 x 68	Poster
850/I/D4	93	73 x 53	68 x 48	Poster

* Doble cara
* Double side

B	↕	↗	↘	?
850/D1	107	87 x 63	82 x 57	A1
850/D3	123	103 x 73	98 x 68	Poster
850/D4	93	73 x 53	68 x 48	Poster



A	↕	↗	↘	?
850/I/M0	87 x 122	82 x 117	1,2	A0
850/I/M1	63 x 87	57 x 82	1,2	A1
850/I/M2	45 x 63	40 x 58	1,2	A2
850/I/M3	73 x 103	68 x 98	1,2	Poster
850/I/M4	53 x 73	48 x 68	1,2	Poster
850/I/M5	32 x 44	29,7 x 42	1,2	A3
850/I/M6	23 x 32	21 x 29,7	1,2	A4

* Marco inglete
* Mitred corner

B	↕	↗	↘	?
850/M0	87 x 122	82 x 117	1,2	A0
850/M1	63 x 87	57 x 82	1,2	A1
850/M2	45 x 63	40 x 58	1,2	A2
850/M3	73 x 103	68 x 98	1,2	Poster
850/M4	53 x 73	48 x 68	1,2	Poster
850/M5	32 x 44	29,7 x 42	1,2	A3
850/M6	23 x 32	21 x 29,7	1,2	A4

* Cantonera redonda negra
* Black round corner

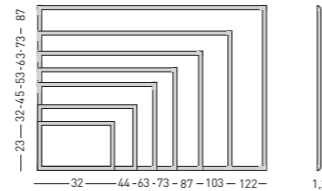

C frame 20, 32, 45 mm.

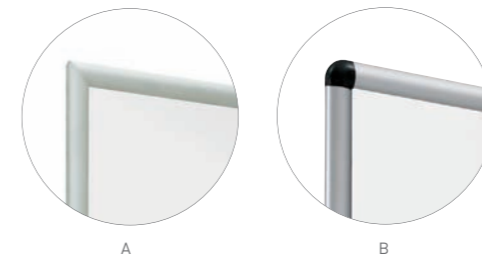

Opcional / Optional
Bajo pedido / Under order
Consultar cantidad / Ask quantity

ES | Portapósters marco abatible

Sistema de presentación de pósters, con marco abatible de aluminio anodizado en plata mate a inglete, que permite la sustitución del impreso de una manera rápida y cómoda.

FR | Cadre mural "clippant"

Porte-affiche en aluminium anodisé couleur argent angles droits. Ces cadres garantissent une excellente tenue des documents. L'affiche des documents sont protégées pour une feuille en plastique transparent anti reflets - anti UV.

IT | Cornice a scatto

Cornice a scatto ad angolo tondo nero profilo mm. 25 con protezione in PVC antiriflesso. Grazie al meccanismo a scatto è semplice e comodo rimpiazzare documenti e poster. Disponibile in tutti i formati DIN per poster.

GB | Wall snapframe

Modern and practical snapframe with durable aluminium clip frames and mitred corners. Folding for posters presentation. Poster or sheets are protected by a thin laminated plastic AV prof non reflects.

DE | Info-plakat

Posterpräsentationssystem mit Klappenrahmentchnik. Die Aluminiumrahmen mit Gehrung geschnittenen Ecken. Die Profile sind silber eloxiert. Eine Folie schützt Ihre Poster vor dem Ausbleichen durch die Sonne. Geliefert in DIN und Póster Format.

PO | Porta poster de parede

Sistema de apresentação de posters com aro em alumínio anodizado na cor prata mate e sem cantos, o aro abre-se facilmente, o que permite a substituição do impreso de uma forma rápida e cómoda.

D perso nalize



Opcional / Optional
Bajo pedido / Under order
Consultar cantidad / Ask quantity

E color RAL



Colores / Colourours
Opcional / Optional
Bajo pedido / Under order
Consultar cantidad / Ask quantity

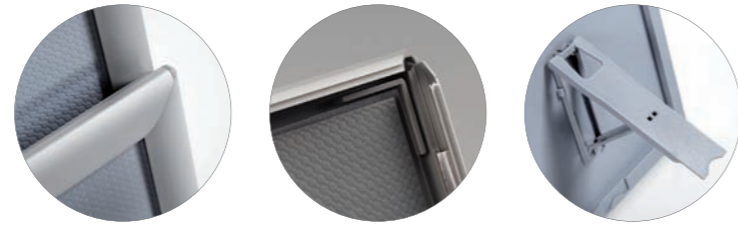

A
colour

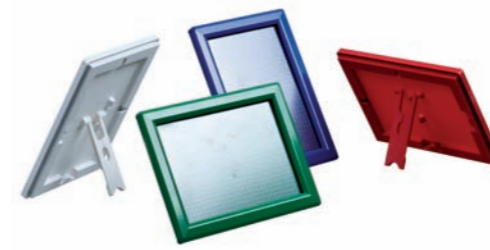

Disponibile en A6, A5 y A4
Available in A6, A5 and A4

B
window
frame

25 & 32 mm.



C
size



Opcional / Optional
Consultar cantidades / Ask quantity

D
water-
proof
frame

25 & 32 mm.



Opcional / Optional
Consultar cantidades / Ask quantity

E
security
frame

25 & 32 & 42 mm.



Opcional / Optional
Consultar cantidades / Ask quantity

F
slide-in
frame

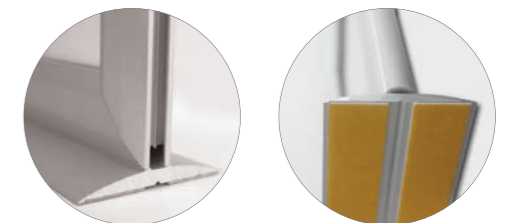

Opcional / Optional
Consultar cantidades / Ask quantity

G
lockable
frame

32 mm.

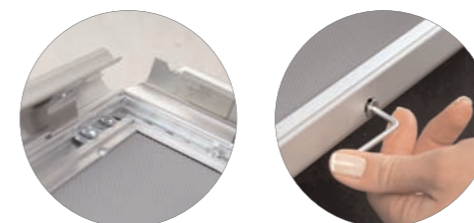

Opcional / Optional
Consultar cantidades / Ask quantity

H
suspendet
slide-in
frame



Opcional / Optional
Consultar cantidades / Ask quantity

144



	↙	↘	?	Λ
BL/EX/0001	12,6 x 16,9	10,5 x 14,8	A6	Sí
BL/EX/0002	16,9 x 23,1	14,8 x 21	A5	Sí
BL/EX/0003	24,1 x 32,8	21 x 29,7	A4	Sí
BL/EX/0004	32,8 x 41,5	29,7 x 42	A3	-
BL/EX/0005	41,5 x 62,5	42 x 59,4	A2	-
BL/EX/0006	53,4 x 73,4	50 x 70	50 x 70	-
BL/EX/0007	62,8 x 87,5	59,4 x 84,1	A1	-

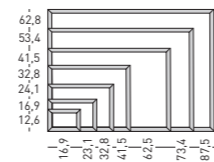

ES | Portapósters marco abatible
Sistema de presentación de pósters, con marco abatible de aluminio anodizado en plata mate a inglete, que permite la sustitución del impreso de una manera rápida y cómoda.

FR | Cadre mural "clippant"
Porte-affiche en aluminium anodisé couleur argent angles droits. Ces cadres garantissent une excellente tenue des documents. L'affiche des documents sont protégées pour une feuille en plastique transparent anti reflets - anti UV.

IT | Cornice a scatto
Cornice a scatto ad angolo tondo nero profilo mm. 25 con protezione in PVC antiriflesso. Grazie al meccanismo a scatto è semplice e comodo rimpiazzare documenti e poster. Disponibile in tutti i formati DIN per poster.

GB | Wall snapframe
Modern and practical snapframe with durable aluminium clip frames and mitred corners. Folding for posters presentation. Poster or sheets are protected by a thin laminated plastic AV prof non reflects.

DE | Info-plakat
Posterpräsentationssystem mit Klappenrahmentchnik. Die Aluminiumrahmen mit Gehrung geschnittenen Ecken. Die Profile sind silber eloxiert. Eine Folie schützt Ihre Poster vor dem Ausbleichen durch die Sonne. Geliefert in DIN und Póster Format.

PO | Porta poster de parede
Sistema de apresentação de posters com aro em alumínio anodizado na cor prata mate e sem cantos, o aro abre-se facilmente, o que permite a substituição do impreso de uma forma rápida e cómoda.

145



A-BOARD



*

WIND SNAP FRAME



A

B

146



* Logo opcional
* Logo optional

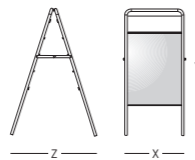

	↔ [A]	↑ [H]	→ [Z]	↙ [X,Y]	⊠ [?]
BL/EX/0060	66,6	123	90	A1	
BL/EX/0061	57,2	123	90	50 x 70	
BL/EX/0062	77,2	142,5	100	70 x 100	

ES | A-Board magnética

Estable y robusto portapóster magnético doble cara que permite el uso tanto interior como exterior. Ideal para áreas públicas, cines, grandes superficies, restaurantes...

FR | A-Board magnétique

Support pour poster stable et robuste et double face, magnétique permettant un usage interne et externe. Idéal pour les espaces publics, les cinémas, grands magasins, restaurants...

IT | Pannello A-Magnetico

Stabile e robusto portaposter magnetico a doppia faccia che permette l'uso sia per interni che esterni. Ideale per aree pubbliche, cinematografi, grandi superfici, ristoranti, etc.

GB | Magnetic A-Board

Magnetic poster holder for inside and outside use, ideal to publish news or information in public area as in malls, shops, restaurants...

DE | Stabiler und robuster Posterständer

Stabiler und robuster Posterständer, zweiseitig, magnetisch, sowohl für draussen als auch drinnen. Ideal für öffentliche Bereiche, Kinos, Restaurants, etc.

PO | A-Board magnética

Estável e robusto porta poster magnético com dupla face que permite a sua utilização em interior e exterior. Ideal para áreas públicas, cinemas, grandes superfícies, restaurantes...

147

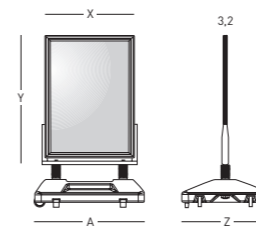

	↔ [A]	↑ [H]	→ [Z]	↙ [X,Y]	⊠ [?]
A WW/A1	82	127,5	65	66,6 x 91,3	59,4 x 84,1
WW/A0	82	165	65	91,3 x 126,1	84,1 x 118,9
WW/B2	70	112,5	55	57,2 x 77,2	50 x 70
WW/B1	82	143	65	77,2 x 107,2	70 x 100

ES | Wind Frame

Gama de portapósters para exterior en versión base rellenable o trípode resistentes a intemperie y viento. El modelo wind water incorpora ruedas para su movilidad. Disponibles en Formatos A2, A1, A0 y 50x70 y 70x100 cm.

GB | Wind Frame

Wind and weather proof poster holders for the outdoor with a big and stable base to be filled or with a tripod. The ref Wind water includes castor to move it easily. Available in A2, A1, A0 and 50x70 and 70x100.

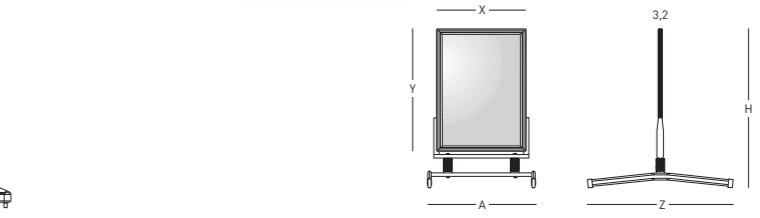

	↔ [A]	↑ [H]	→ [Z]	↙ [X,Y]	⊠ [?]
B SW/A2	55,4	101	90	49,2 x 66,6	42 x 59,4
SW/A1	72,8	115	105	66,6 x 91,3	59,4 x 84,1
SW/A0	97,5	150	140	91,3 x 126,1	84,1 x 118,9
SW/B2	63,4	101	90	57,2 x 77,2	50 x 70
SW/B1	83,4	131	124	77,2 x 107,2	70 x 100

FR | Wind water frame

Gamme de porte posters pour espaces de plein, version avec base rechargeable ou avec un trépied résistant aux intempéries et au vent. Le modèle incorpore roulettes hydrauliques wind de mobilité. Formats disponibles en A2, A1, A0 et 50x70 et 70x100 cm.

DE | Sortiment von Posterständern f. draussen

Sortiment von Posterständern für den Aussenbereich, mit füllbarem Fuss oder standfestem Dreibein. Das Modell wind/water ist zum leichten Transport mit Rollen ausgestattet. Erhältlich in den Formaten: A2, A1, A0 und 50 x 70 und 80 x 100.

IT | Struttura a vento

Gamma di prodotti per uso esterno in versione con rotelle o trípode. Resistenti a intemperie e vento. Il modello wind water ha ruote incorporate per la mobilità. Disponibile in formati A2, A1, A0, e 50x70 e 70x100.

PO | Wind Frame

Gama de porta pósteres para exterior em versão com base de encher ou tripé resistentes à chuva e ao vento. O modelo wind water ha rodas para poder ser movimentado. Disponíveis nos formatos A2, A1, A0 e 50x70 e 70x100 cm.



148



	↔	↑	□
SWG/GR	60 x 93,5	42 x 59,4	40 x 57,5
SWG/RJ	60 x 93,5	42 x 59,4	40 x 57,5
SWG/NG	60 x 93,5	42 x 59,4	40 x 57,5

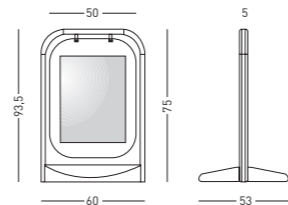

ES | Portapóster magnético

Portapóster magnético para uso interior y exterior suspendido sobre estructura metálica y base de plástico. Ideal para espacios públicos como cines, grandes superficies, estaciones de servicio, restaurantes, etc...

GB | Magnetic poster holder

Magnetic poster holder for both use in and outdoor, suspended on a metallic structure and plastic base. Ideal for the public spaces as cinemas, malls, gas station, restaurants...

FR | Snapframe magnétique

Cadre snapframe magnétique et métallique pour usage en intérieure et extérieure sur cadre suspendu et base en plastique. Idéal pour les espaces publics comme les cinémas, supermarchés, stations-service, restaurants...

DE | Magnetaftender Posterständer

Magnetaftender Posterständer für den Aussen- und Innenbereich, aufgehängt auf einer Metallstruktur und auf der Grundlage von Plastik. Ideal für öffentliche Bereiche, Kinos, Restaurants, etc.

IT | Portaposter magnetico

Portaposter magnetico per uso per interni che per esterni, sospeso su la struttura metallica e basamento in plastica, ideale per spazi pubblici come cinema, grandi superfici, stazioni di servizio, ristoranti, etc.

PO | Portaposter magnético

Porta poster magnético, para utilização interior ou exterior, suspenso sobre uma estrutura metálica e com base em plástico. Ideal para espaços públicos como cinemas, grandes superfícies, estações de serviço, restaurantes, etc...

149

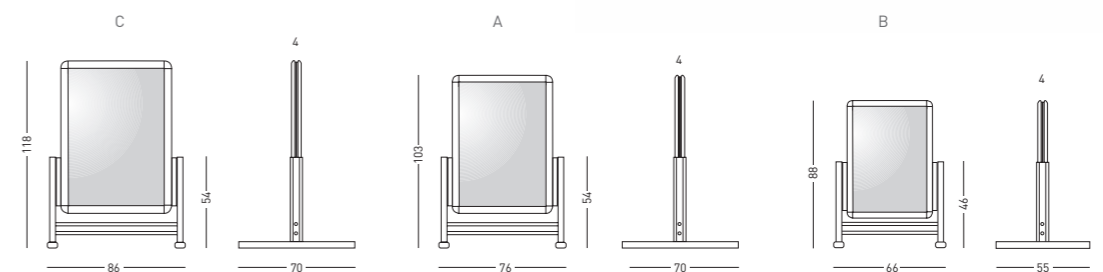

	↔	↑	□
A 850/AMI/A1	76	103	70
B 850/AMI/B2	66	88	55
C 850/AMI/B1	86	118	70

	↔	↑	□
A 850/AMI/A1	76	103	70
B 850/AMI/B2	66	88	55
C 850/AMI/B1	86	118	70

ES | Portapósters inglete doble cara

Gama de portapósters doble cara para uso interior en versión a inglete o cantoneras redondeadas. Estructura y portapóster de perfil de 32 mm. fabricada de aluminio anodizado plata mate. Ideal para espacios públicos como cines, centros comerciales, restaurantes, etc...

GB | Poster holders double sided

Range of poster holders double sided for the inside with rounded plastic or mitred corners. Profile and structure size is 32 mm. Made of anodised aluminium silver mat. Ideal for the public spaces as cinemas, shops, malls, restaurants, etc...

FR | Support pour posters

Gamme de support pour posters pour utilisation en intérieurs versions avec coins arrondis ou en angle droit. Structure snapframe et du profil de 32 mm. Couleur argent mat en aluminium anodisé. Idéal pour les espaces publics comme les cinémas, les centres commerciaux, les restaurants...

DE | Sortiment von zweiseitigen Posterständern

Sortiment von zweiseitigen Posterständern für den Innenbereich, mit spitzen oder abgerundeten Ecken. Struktur und Posterunterlage aus 32mm anodisiertem Aluminium matt silber. Ideal für öffentliche Bereiche, Kinos, Restaurants, etc.

IT | Portaposter a spigolo a doppia facciata

PGamma di portaposter a doppia facciata per uso da interni in versione a spigolo o con profili angolari arrotondati. Struttura e portaposter con profilo di 32 mm. realizzato in alluminio anodizzato argento opaco. Ideale per spazi pubblici come cinematografi, centri commerciali, ristoranti, etc.

PO | Portaposter a spigolo a doppia facciata

Gama de porta posters dupla face para utilização em interior, em versão esquadria ou com cantos pretos. Estrutura e porta poster com perfil de 32mm. em alumínio na cor prata mate. Ideal para espaços públicos como cinemas, centros comerciais, restaurantes, etc...



150

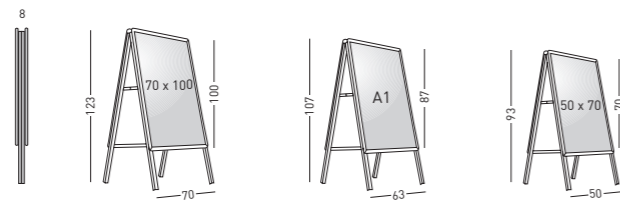

A	↔	↑	↳
DB/B/M1	63 x 87	107	8
DB/B/M3	70 x 100	123	8
DB/B/M4	50 x 70	93	8

B	↔	↑	↳
DB/V/M1	63 x 87	107	8
DB/V/M3	70 x 100	123	8
DB/V/M4	50 x 70	93	8

C	↔	↑	↳
DB/N/M1	63 x 87	107	8
DB/N/M3	70 x 100	123	8
DB/N/M4	50 x 70	93	8

151

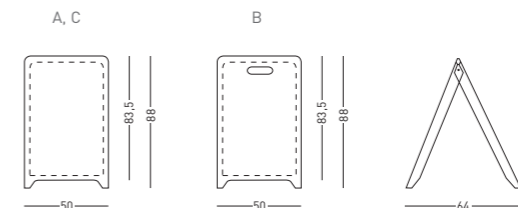

A, C	↔	↑	↳
A PSB/01	50 x 88	50 x 83,5	64
B PSB/02	50 x 88	50 x 83,5	64
C PSB/03	50 x 88	50 x 83,5	64

ES | Pizarra caballete laminada doble cara
Estable y robusto caballete doble cara que permite el uso tanto interior como exterior. Versión blanca rotulable con rotuladores de borrado en seco y verde y negra para escritura con tiza o rotuladores de tinta líquida. Ideal para áreas públicas, grandes superficies, restaurantes...

FR | Chevalet double face
Chevalet stable et robuste à double face pour une utilisation en intérieur et en extérieur. La version tableau blanc avec marqueurs effaçables à sec et noir et vert pour écrire à la craie ou des stylos à encre liquide. Idéal pour les espaces publics, supermarchés, restaurants...

IT | Cavalletto laminato a doppia facciata
Stabile e robusto cavalletto a doppia facciata che permette un uso sia per interni che per esterni, versione bianca scrivibile con pennarelli e cancellabile o verde e nera per scrittura con gessetti o pennarelli liquidi. Ideale per aree pubbliche, grandi superfici, ristoranti, etc.

ES | Caballete de plástico
Simple y práctico caballete de plástico doble cara que permite situarse en el exterior, ideal para colocar vinilos impresos, o rotular mediante tiza o tiza líquida. Disponible también versión con asa para facilitar el transporte. Ideal para restaurantes, bares, centros comerciales...

FR | Chevalet de plastique
Chevalet simple et pratique double face avec support en plastique pour l'extérieur, idéal pour placer des autocollants, imprimés ou étiquetés ou craie, de l'encre liquide. Disponible aussi un modèle avec poignée pour faciliter le transport. Idéal pour les restaurants, bars, centres commerciaux...

IT | Cavalletto plastico
Semplice e pratico cavalletto in plastica con doppia facciata che permette di utilizzarlo all'esterno, ideale per collocare comunicati in vinile o scrivere con gessetti o pennarelli liquidi. Disponibile anche con asola per facilitare il trasporto. Ideale per ristoranti, bars e centri commerciali.

GB | Aboard double sided
Strong and stable A board double sided for both uses in ant outdoor. White board with dry markers pens and green or black one for traditional chalk or liquid ink pens writing. Ideal for restaurants, malls, public areas...

DE | Stabiler und robuster Klappständer
Stabiler und robuster Klappständer, zweiseitig, sowohl für innen als auch draussen. In weiss, zum Gebrauch von trocken abwischbaren Markern und in grün oder schwarz zum Beschriften mit Kreide oder feuchten Markern. Ideal für öffentliche Bereiche, Kinos, Restaurants, etc.

PO | Cavalete dupla face
Estável e robusto cavalete dupla face que permite a sua utilização em interior e exterior. Versão branca para utilizar com marcadores de limpeza a seco e verde/preta para escrita com giz ou marcadores de tinta líquida. Ideal para áreas públicas, grandes superfícies, restaurantes...

GB | Plastic Aboard double sided
Simple and easy plastic A Board double sided for both in and outdoor use. Ideal to be printed or with vinyl and for chalk or liquid ink pens. Also available in handy movable version. Ideal for restaurants, malls...

DE | Einfacher und praktischer Klappständer
Einfacher und praktischer Klappständer aus Plastik, zweiseitig, für den Aussenbereich, zum anbringen von Aufklebern oder zum Beschriften mit Kreide oder feuchter Kreide. Erhältlich auch mit Tragegriff zum leichten Transport. Ideal für öffentliche Bereiche, Kinos, Restaurants, etc.

PO | Cavalete de plástico
Simples e práctico cavalete de plástico dupla face que permite ser colocado no exterior, ideal para colocar vinil impresso, ou para utilizar com giz ou marcadores de tinta líquida. Disponível também na versão com asa para facilitar o transporte. Ideal para restaurantes, bares, centros comerciais...

POSTER SNAP

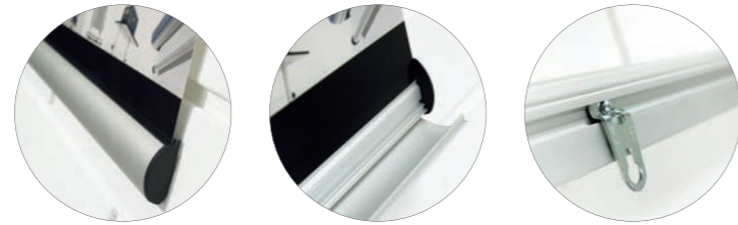

152

POSTER FRAME



153

	Póster	External	?
852/A4	21	21,6	A4
852/A3	30	30,6	A3
852/A2	42	42,6	A2
852/A1	60	60,6	A1
852/A0	85	85,6	A0
852/P5	50	50,6	50 x 70
852/P7	70	70,6	70 x 100

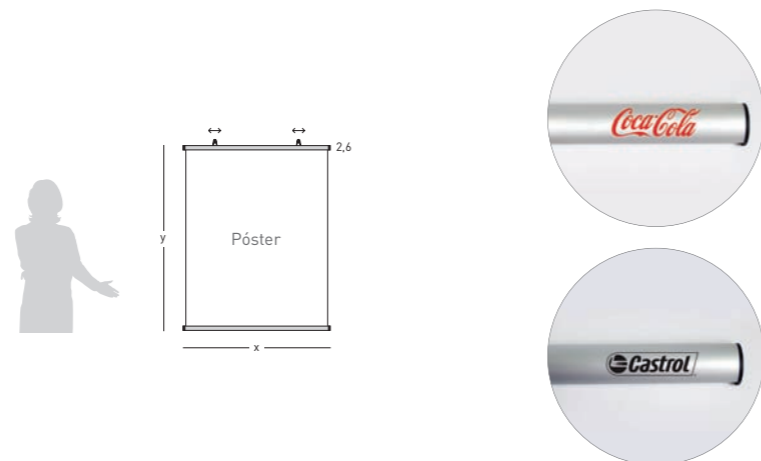

ES | Banner portapósters

Suspendido doble cara de marco abatible de aluminio anodizado en plata mate, que permite la sustitución del impreso de una manera rápida y cómoda mediante el perfil en forma de pinza que sujeta el póster mediante sistema de clip.

FR | Banner porte-affiches

Profil clippant en aluminium anodisé couleur argent pour poster par suspension. Facile à accrocher ainsi que pour changer l'information. Simple ou double face.

IT | Postersnapper a sospensione

Coppia di profili a scatto per sospensione di poster e banner; la gomma antiscivolo all'interno del profilo garantisce una perfetta tenuta del poster, completo di n.2 ganci in metallo per sospensione.

GB | Wall suspended postersnapper

Double sided banner display made of silver anodised aluminium. Ideal for fixing posters or light paper banners. The clamp profiles guarantee quick and easy exchange of the banner. Easily erected and dismantled. Available in A size and póster formats.

DE | Wand-Klemmleisten (Zum Aufhängen)

Flexibel nutzbares zweiseitiges Banner Display aus anodisiertem Aluminium. Die Klemmleisten garantieren ein schnelles und problemloses Auswechseln der Motive. Leichte Auf- und Abbau. Geliefert in DIN und Póster Format.

PO | Barras em alumínio para poster

Barras para suspensão de poster de dupla face, para apresentação de posters ou bandeirolas, com aro de abrir em alumínio anodizado na cor prata mate, que permite a substituição do documento de uma forma rápida e cómoda com o perfil em forma de pinça.

	↳ (x,y)	↳ Póster	↳	?
854/A4	31 x 39,7	21 x 29,7	0,5	A4
854/A3	39,7 x 52	29,7 x 42	0,5	A3
854/A2	52 x 69,4	42 x 59,4	0,5	A2
854/A1	69,4 x 94,1	59,4 x 84,1	0,5	A1
854/P5	60 x 80	50 x 70	0,5	Póster
854/P6	80 x 100	70 x 100	0,5	Póster

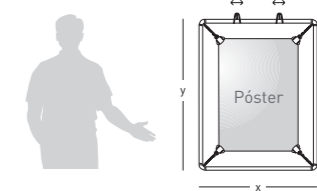

ES | Marco tensapósters suspendidos

Marco tensapósters suspendido doble cara, para presentación de pósters o banderolas. El sistema consiste en un marco de aluminio que en sus ángulos tiene unos muelles provistos de una pinza que sujetan el póster manteniéndolo tensado.

FR | Cadre à suspendre

Cadre baguette pour poster ou banderoles double face et/ou mural. Profil en aluminium avec des ressort montés dans les angles avec des pinces pour la planéité et tension du document. L'information est facile à changer. Disponible en plusieurs formats et posters.

IT | Poster display a sospensione

Profilo in alluminio leggero completo di molle laterali per fissaggio poster semplice da montare e smontare.

GB | Suspended poster display

Double sided banner display made of silver anodised aluminium. The clamp on springs profiles guarantee quick and easy exchange of the banner. Easily erected and dismantled. Available in A size and póster formats.

DE | Poster display (zum Aufhängen)

Elegante und dennoch preiswerte Möglichkeit der Posterpräsentation aus silber anodisiertem Aluminium. Durch die Eckverbindungen entsteht der Eindruck eines Rahmens. Die Spannfedern und Krokodilklemmen gewährleisten einen mühelosen Posterwechsel.

PO | Aro para poster

Aro suspenso para poster de dupla face, para apresentação de posters ou bandeirolas. O sistema consiste num aro de alumínio que nos cantos tem umas molas com uma pinça que suportam o poster mantendo-o esticado.

LIGHT BOX

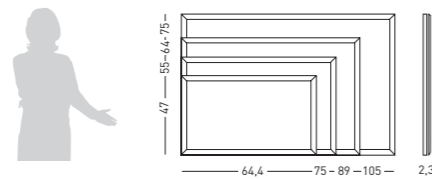

	↕	↔	↔	💡
862/A2	45,2 x 62,6	42 x 59,4	2,3	2200 - 2400 w
862/A1	62,6 x 87,3	59,4 x 84,1	2,3	2200 - 2400 w
862/P4	53,2 x 73,2	50 x 70	2,3	2200 - 2400 w
862/P5	73,2 x 103,2	70 x 100	2,3	2200 - 2400 w

ES | Caja de luz (Led)

Caja de luz mediante leds con marco abatible de aluminio anodizado en plata mate. Permite la sustitución del impreso de una manera rápida y cómoda. Incorpora plástico transparente anti-reflex. Disponible en formatos Din y Póster.

6B | Light box for poster (Led)

Light box for posters with anodized aluminium snap frame for light spread. The poster is covered with a UV-stabilized / antireflex plastic foil.

FR | Support porte-affiche éclairé (Led)

Support éclairé pour affiche ou poster avec cadre clippant en aluminium anodisé pour diffusion lumineuse. L'affiche est recouverte d'une feuille de plastique anti-reflets et anti-UV.

DE | Leuchtkasten (Led)

Leuchtkasten (Led) mit Klappenrahmentechnik in Silber matt eloxiertem Aluminium. Ermöglicht einen schnellen und einfachen Austausch der Druckschrift. Mit einer UV-stabilisierten Antireflex-Folie, die vor dem Ausbleichen durch die Sonne schützt.

IT | Scatola di luce (Led)

Cofanetto di luci Led con cornice ribaltabile in alluminio anodizzato colore argento opaco. Permette di sostituire l'impreso in modo comodo e veloce. Include plastica trasparente anti-riflesso. Disponibile nei formati DIN e Poster.

PO | Caixa de luz (Led)

Caixa de luz com leds, com perfil em alumínio anodizado na cor prata mate. Permite a substituição do documento no seu interior de uma forma muito rápida e cómoda. Inclui um plástico transparente antireflexo. Disponível nos formatos DIN e poster.



LIGHT TOTEM

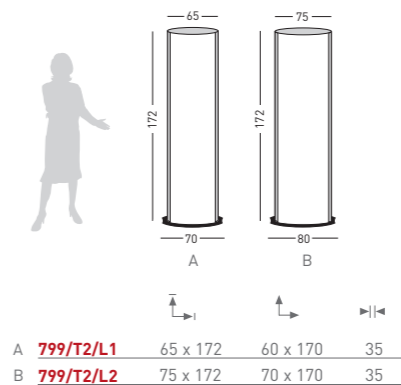

A	799/T2/L1	65 x 172	60 x 170	35
B	799/T2/L2	75 x 172	70 x 170	35

ES | Totem perfil curvo con luz

Tótem curvo vertical doble cara, fabricado con perfil de aluminio de marco abatible anodizado en color plata mate. El soporte permite la incorporación del documento mediante un sistema de clip, retirando previamente el plástico transparente que lo protege.

6B | Curved profile totem with light

Curved profile double sided totem with durable aluminium snap frames, which allow you to place texts and pictograms through a snap system. With a suction cup pull off the transparent sleeve to change the text.

FR | Totem courbe avec éclairage

Totem double face, profil courbe, sur profilés aluminium anodisé. Le support permet l'incorporation de papier (pictos ou texte) par le système «clippant». Grâce à une ventouse on peut enlever le plastique transparent qui protège le support.

DE | Gewölbtes-Profil Totem mit Licht

Gewölbtes-Profil Totems beidseitig mit anodisiertem Alu-Profil hergestellt. Mit Klappenrahmentechnik. Mit einer Kunststoff beschichtung versehen, die sich gut zum Mehrfachkleben oder Bedrucken von Texten oder Pictos eignet.

IT | Totem luminoso

Totem luminoso in profilo alluminio anodizzato curvo. Grazie al meccanismo a scatto facilità di intercambiare poster o documenti. Protezione in PVC antiriflesso. Ideale per showroom, fiere, manifestazioni, ecc..

PO | Totem em perfil curvo com luz

Totem vertical de dupla e tripla face em perfil curvo. É fabricado com perfil de alumínio anodizado na cor prata mate. O suporte permite a colocação do papel (pictograma ou texto). Através de uma ventosa especial pode-se levantar frontalmente o plástico.

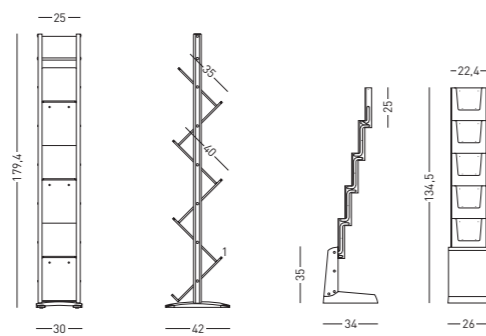
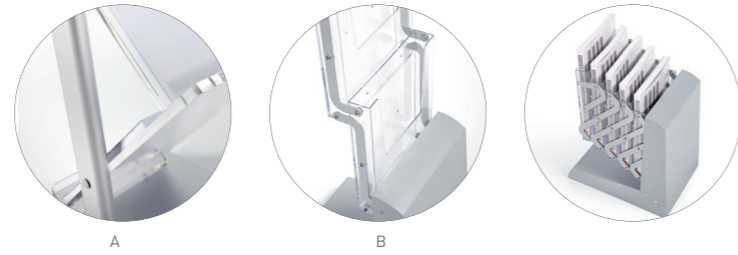

A
BL/EX/0210 42 x 162 6 x A4

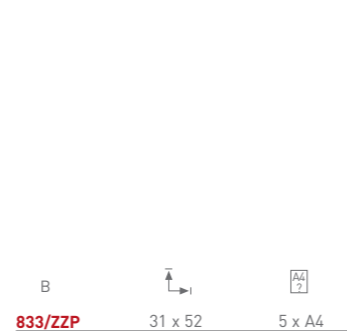

B
833/ZZP 31 x 52 5 x A4

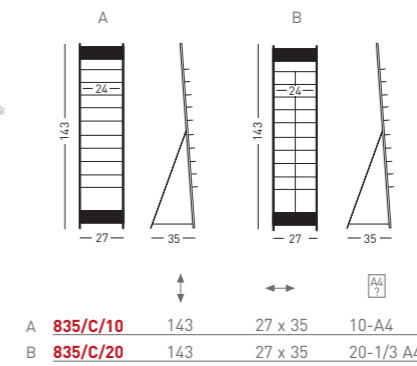

A 835/C/10 143 27 x 35 10-A4
B 835/C/20 143 27 x 35 20-1/3 A4

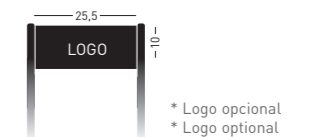

* Logo optional
* Logo optional

ES | Portacatálogos Zig-Zag portátil
Gama de expositores Zig-Zag de pie para revistas y catálogos construidos en aluminio y/o metacrilato y de formato A4. Estructuras desmontables o plegables. Ideal para ferias, congresos, exposiciones, etc...El modelo 833/ZZP incluye bolsa de transporte.

FR | Display Zig-Zag portable
Gamme de display exposants sur pied Zig-Zag pour les magazines et catalogues fabriqué en aluminium et/ou en méthacrylate format A4. Structures amovibles ou pliables. Idéal pour les salons professionnels, conférences, expositions... Le modèle 833/ZZP avec sac de transport.

IT | Portacataloghi Zig-Zag portatili
Gamma di espositori Zig-Zag da terra per riviste e cataloghi realizzati in alluminio e/o metacrilato in formato A4. Struttura ripiegabile e riducibile. Ideale per fiere, congressi, esposizioni, etc. Il modello 833/ZZP include una borsa per il trasporto.

ES | Expositores para catálogos
Expositores para catálogos y/o revistas verticales construidos con varilla negra y cromada. Su estructura es desmontable y plegable y está disponible para catálogos formato A4 (Disponible en 5 y 10 casillas) y trípticos 1/3 de A4 (Disponible en 20 casillas).

FR | Présentoirs
Présentoir à catalogues et/ou revues verticales fabriqués en métal noir et chromée. Structure démontable et pliable pour formats A4 (5 et 10 encoches) et 1/3 A4 (20 encoches).

IT | Espositore per cataloghi
Espositore porta cataloghi o riviste costruito con sistema cromato nero. E' possibile smontare facilmente la struttura per uso temporaneo. Disponibile per cataloghi A4 ed 1/3 A4.

GB | Zig-Zag display for catalogues
Range of Zig-Zag display for catalogues and magazines made of aluminium and/or methacrylates with pocket size for A4. Dismountable structure and foldable. Ideal for exhibition, fairs, hotels...The ref. 833/ZZP includes a bag.

DE | Sortiment von Prospektständern Zig-Zag
Sortiment von Prospektständern Zig-Zag, für Kataloge und Zeitschriften aus Aluminium und Plexiglas im Format A4. Demontierbar und faltbar. Ideal für Messen, Ausstellungen, Kongresse etc. Das Model 833/ZZP wird mit einem Transportbeutel geliefert.

PO | Expositor para catálogos em Zig-Zag
Gama de expositores Zig-Zag de chão para revistas e catálogos construídos em alumínio e/ou acrílico e em formato A4. Estruturas desmontáveis. Ideal para feiras, congressos, exposições, etc...O modelo 833/ZZP inclui bolsa para transporte.

GB | Information racks
Information racks for catalogues and/or magazines manufactured with black chrome stems. Dismantle the structure easily for temporary use. Available for catalogues in A4 format (5 and 10 trays) and brochures 1/3 A4 (20 trays).

DE | Prospektständer
Prospektständer für Kataloge und/oder senkrechte Zeitschriften, mit schwarzem und verchromtem Gitter hergestellt. Faltbare Struktur, Format A4 (5 und 10 Prospektfächer) und Broschüren 1/3 A4 (20 Prospektfächer).

PO | Expositor de catálogos
Expositor para catálogos e/ou revistas verticais, construído em vareta preta e cromada. A sua estrutura é desmontável e fecha-se. Está disponível para catálogos formato A4 (Disponível em 5 e 10 compartimentos) e trípticos 1/3 de A4 (Disponível com 20).

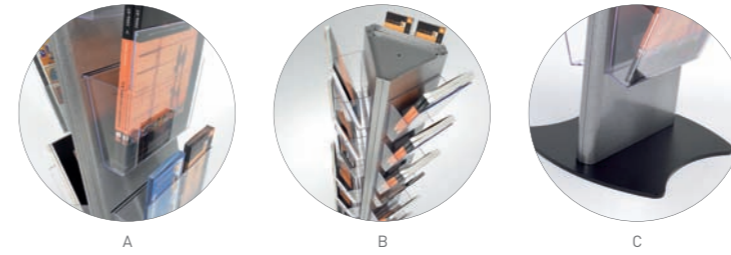

* Versión mural
* Wall version



* Casilleros no incluidos.
* Trays not included.

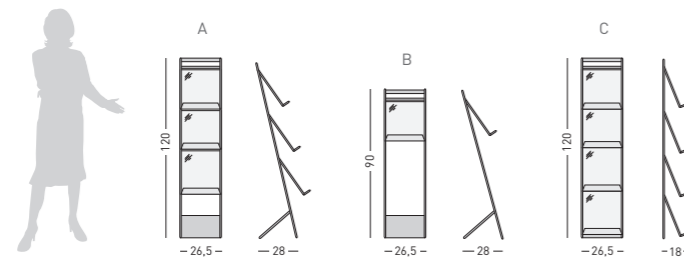

	A	B	C
Height	120	90	120
Width	26,5	26,5	26,5
Depth	28	28	18
Capacity	3 - A4	1 - A4	4 - A4

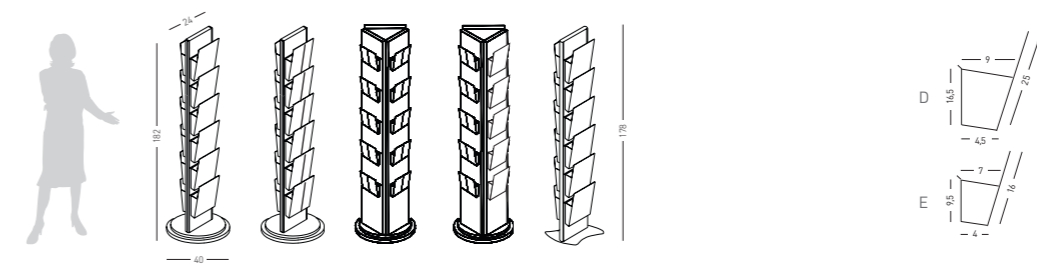

	A	B	C	D	E
Height	182	182	178	185	185
Width	24	24	24	16	16
Depth	40	40	40	11	11
Capacity	12	21	12	1	100
Tray Size	A4	A4	A4	A4	1/3 A4

ES | Expositor para catálogos (de pie y mural)
Expositor para catálogos y/o revistas vertical construido en aluminio y estantes de metacrilato. Su estructura es desmontable y posee una capacidad de 1 ó 3 estantes para la versión de pie y 4 estantes para la versión mural.

FR | Présentoir (pietement et mural)
Présentoir à catalogue et/ou magazines, structure (démontable) en aluminium et étagères en méthacrylate. Pour 1 ou 3 étagères (finition avec piètement) et 4 étagères (finition murale).

IT | Espositore ad contenitore
Espositore da porre a pavimento od a muro per cataloghi o riviste con supporto in alluminio e contenitori in plexiglass. La struttura può essere assemblata e smontata facilmente per uno temporaneo.

ES | Expositores personalizables "Torre"
Gama de expositores metálicos de dos o tres caras sobre base negra fija o giratoria pintados de color gris metalizado. En las ranuras de la torre se acoplan los casilleros VIS/A4 (A4) y VIS/1/3/A4 (1/3 A4), pudiendo obtener la configuración de portafolletos deseada.

FR | Présentoirs personnalisables "Torre"
Gamme de présentoirs en métal, double ou triple face sur socle noir fixe ou rotatif peint en gris métallisé. Les portes brochures VIS/A4 (A4) et VIS/1/3/A3 (1/3 A4) s'emboîtent sur les panneaux rainurés de la tour, pour obtenir ainsi la composition souhaitée de portes brochures.

IT | Espositore porta depliant "Torre"
Elegante espositore a pavimento con struttura in lamiera tagliata al laser, disponibile nella versione bifacciale, sia su base fissa che girevole e nella versione a 3 lati su base girevole; componibile con le tasche VIS/A4 (A4) e VIS/1/3/A3 (1/3 A4).

GB | Exhibitor display (Floor and wall)
Exhibitor displays to place on floor or wall for catalogues and/or magazines with aluminium support beams and plexi glass trays. The structure can be assembled and dismantled easily for temporary use. A maximum of 3 trays (floor) set up and 4 trays (wall).

DE | Prospektregal (Wand- und auf Fuß)
Stabile Konstruktion aus alu-silber mit Fächern aus transparentem und bruchsicherem Acryl. Ideal zur Präsentation von Prospekten oder Katalogen. Mit 1 oder 3 Fächern (auf Fuß) oder 4 Fächern (Wand-). Zusammenfaltbar.

PO | Expositor (de pé e de parede)
Expositor para catálogos e/ou, revistas, vertical construído em alumínio e prateleiras em acrílico. A sua estrutura é desmontável e tem capacidade de 1 ou 3 prateleiras para a versão de pé e 4 prateleiras para a versão de parede.

GB | Personalize exhibitors "Torre"
Range of metal 2 or 3-sides displays placed on a fixed or swivel black base painted in metallic grey. The VIS/A4 (A4) and VIS/1/3/A4 (1/3 A4) can be fitted into the Tower slots, getting the desired document holders structure.

DE | Struktur "Torre" grau
Prospektänder aus Metall mit 2 oder 3 Seiten und auf schwarz festem oder drehbarem Fuß gestellt. Die sind in grau gefärbt. Die Fächer VIS/A4 (A4) und VIS 1/3 A4 (1/3 A4) sind zwischen den Schlitzen zusammengefügt, um eine wünschenswerte Bildung zu erschaffen.

PO | Estrutura personalizável "Torre"
Gama de expositores metálicos de duas ou três faces sobre uma base preta fixa ou giratória pintados na cor cinzento metalizado. Nas ranhuras da torre adaptam-se os compartimentos VIS/A4 (A4) e VIS/1/3/A4 (1/3 A4), podendo obter a configuração desejada.

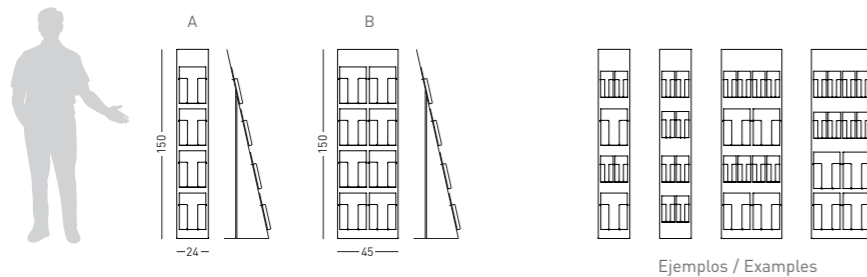

Ejemplos / Examples

A	837/24	150	24	4 - A4
B	837/45	150	45	8 - A4

- Casilleros no incluidos.
- Trays not included.

C	V/A4	30 x 21	3	A4
D	V/A5	21 x 15	3	A5
E	V/A4/3	15 x 10	3	1/3 A4

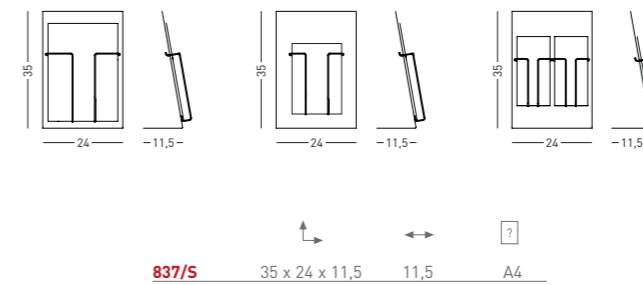

837/S 35 x 24 x 11,5 11,5 A4

A	V/A4	30 x 21	3	A4
B	V/A5	21 x 15	3	A5
C	V/A4/3	15 x 10	3	1/3 A4

ES | Expositor de chapa "Alians"

Expositor de chapa con cajetines de varilla metálica formando la composición deseada en cada momento. Las cajetines están disponibles en Din A4, A5 y formato tríptico. La parte superior puede ser rotulada o vinilada bajo pedido.

FR | Présentoir incliné "Alians" en métal

Présentoir incliné "Alians" en métal perforé avec porte-brochures en tiges métalliques. Composition modulable sur formats A4 et A5 et tryptique. La partie supérieure peut être personnalisée (logo ou texte).

IT | Espositore inclinato "Alians" in lamiera

Espositore in lamiera perforata con cassetti di stecca metallica che permettono di ottenere la composizione desiderata in ogni momento. I cassetti sono disponibili nelle dimensioni A4, A5 e formato triptico. La parte superiore può essere arrotondata o vinilizzata.

ES | Expositor "Alians" de sobremesa

Expositor de sobremesa de chapa perforada para cajetines de varilla metálica. Las cajetines de varilla están disponibles en Din A4, A5 y formato tríptico.

FR | Présentoir "Alians" à poser

Présentoir à poser en métal perforé avec porte-brochures en tige métallique formats A4, A5 et 1/3 de A4.

IT | Espositore "Alians" da tavolo

Espositore da tavolo in lamiera perforata per cassetti di stecca metallica. I cassetti sono disponibili nelle dimensioni A4, A5 e formato triptico.

GB | Inclined display "Alians" in metal

Inclined display "Alians" made of perforated metallic structure and surface with metallic wire trays. Trays sizes can be A4, A5 or 1/3 of A4. Upper side can be personalized (logo or text).

DE | Prospektständer mit Siebblech "Alians"

Prospektständer mit Siebblech mit Ablagefächern mit metallischer Drehschiene zur optimalen Einstellung. Die Ablagefächer sind in den Formaten Din A 4 und A 5 und dreiteilig erhältlich. Beschriftbar.

PO | Expositor inclinado "Alians" em chapa

Expositor em chapa perfurada, com porta folhetos em vara metálica, formando a composição desejada. Os porta folhetos estão disponíveis em DIN A4, A5 e formato tríptico. A parte superior pode ser personalizada mediante pedido.

GB | Display "Alians" for table

Display for table in grey perforated metal with metallic wire trays for documents A4, A5 or 1/3 of A4.

DE | Prospektständer "Alians" mit Siebblech

Prospektständer mit Siebblech mit metallischen Ablagefächern. Die Ablagefächer sind in den Formaten A4 und A5 und dreiteilig erhältlich. Die Oberfläche ist beschriftbar.

PO | Expositor "Alians" de mesa

Expositor de mesa em chapa perfurada, com porta folhetos em vara metálica. Os porta folhetos estão disponíveis em DIN A4, A5 e formato tríptico.



*



G



* Rótulo no incluído, ver pág. 282
* Sign not included, see pg. 282



* Rótulo no incluído, ver pág. 282
* Sign not included, see pg. 282

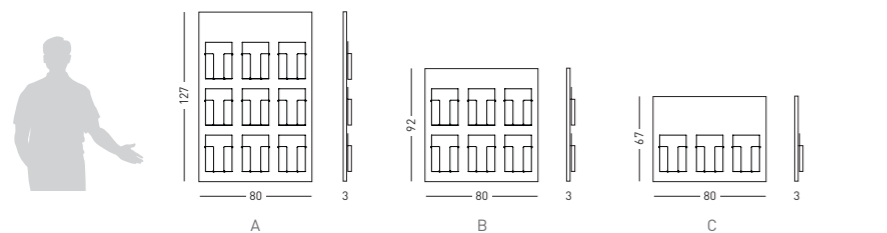

	A	B	C
Height	127	92	67
Width	80	80	80
Trays	9 - A4	6 - A4	3 - A4

- Casilleros no incluídos.
- Trays not included.



	D	E	F
Height	30	21	15
Width	21	15	10
Trays	3	3	3

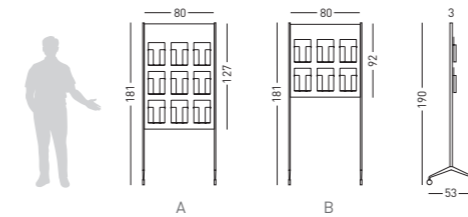

	A	B
Height	190	190
Width	127 x 80	92 x 80
Trays	9 - A4	6 - A4

- Casilleros no incluídos.
- Trays not included.

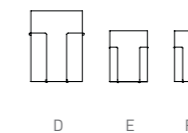

	D	E	F
Height	30	21	15
Width	21	15	10
Trays	3	3	3

	G
Height	2 x 75
Trays	0,2

ES | Panel "Expo-Wall" mural

Conjunto portafolletos mural de chapa perforada para cajetines de varilla metálica disponibles en Din A4, A5 y formato tríptico. La parte superior puede ser rotulada o vinilada (no incluye rótulo).

FR | Présentoir "Expo-Wall" mural

Présentoir mural en métal perforé. Porte-brochures en tige métal aux formats A4 et A5. La partie supérieure peut être personnalisée sur un ruban de signalétique (profil de signalétique non inclus).

IT | Pannello informativo "Expo-Wall"

Gruppo di portafogli da parete in lamiera perforata per cassetti di stecca metallica disponibili nelle dimensioni A4, A5 e formato tríptico. La parte superiore può essere arrotondata o vinilizzata. (L'Segnaletica non è inclusa).

ES | Panel "Expo-Ten" con soporte Y2

Conjunto portafolletos de chapa perforada sobre soporte con ruedas Y2 sobre el cual se sitúan cajetines de varilla metálica disponibles en Din A4, A5 y formato tríptico. La parte superior puede ser rotulada o vinilada. (rótulo no incluído).

FR | Présentoir "Expo-Ten" sur piétements Y2

Présentoir en métal perforé sur piétement "Y2" avec roulettes ou verins. Porte-brochures en tige de métal aux formats A4 et A5. Disponible en double face. La partie supérieure peut être personnalisée (écriture ou vinyle).

IT | Pannello "Expo-Ten" supporto Y2

Gruppo di portafogli in lamiera perforata su supporto con ruote Y2 sopra il quale si situano cassetti di stecca metallica disponibili nelle dimensioni A4, A5 e formato tríptico. La parte superiore può essere arrotondata o vinilizzata. (L'Segnaletica non è inclusa).

GB | Wall display "Expo-Wall"

Range of wall displays made of perforated metallic surface and with A4 and A3 or 1/3 of A4 wire trays. The upper board can be personalized or signed with vinyl or with curved or flat profile.

DE | Wand tafel "Expo-Wall"

Prospektaufsteller aus durchlöcherter Blech für Walzdraht-Fächen in A4, A5 und 1/3 A4-Format. Im oberen Teil des Produktes können Schildern oder Vinyl beschriftet werden (ohne Beschilderung).

PO | Expositor "Expo-Wall" de parede

Expositor em chapa perfurada de parede para porta folhetos em vara metálica. Os porta folhetos estão disponíveis em DIN A4, A5 e formato tríptico. A parte superior pode ser personalizada (sinalética não incluída).

GB | Display "Expo-Ten", with Y2 support

Display in perforated metal with "Y2" support on castors or jacks. Metallic wire trays A4 or A5. The upper board can be personalized or signed with vinyl or with curved or flat profile.

DE | Tafel "Expo-Ten" mit Y2

Prospektaufsteller aus durchlöcherter Blech mit Fuß Y2 für Walzdraht-Fächen in Din A4, A5 und 1/3 A4-Format. Im oberen Teil des Produktes können Schildern oder Vinyl beschriftet werden (ohne Beschilderung).

PO | Expositor "Expo-Ten" com suportes Y2

Expositor em chapa perfurada, colocado num suporte com rodas "Y2", no qual são colocados porta folhetos em vara metálica. Os porta folhetos estão disponíveis em DIN A4, A5 e formato tríptico. A parte superior pode ser personalizada (sinalética não incluída).



* Rótulo no incluido, ver pág. 270
* Sign not included, see pg. 270

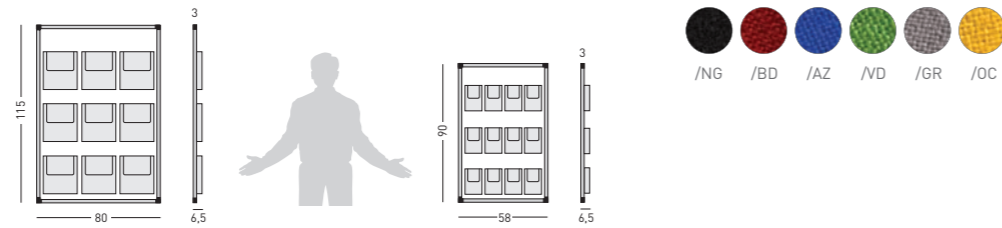

840/G	115 x 80	3	9 - A4
--------------	----------	---	--------

840/P	90 x 58	3	12 - 1/3 A4
--------------	---------	---	-------------

ES | Portafolletos murales y con pié
Portafolletos de metacrilato DIN A4 y 1/3 DIN A4 montados sobre tableros tapizados en téxtil y enmarcados con perfil de aluminio. Bajo presupuesto pueden fabricarse combinaciones con formatos de cajetines (Din A4, A5 y tríptico).

FR | Porte brochures
Porte Brochures en méthacrylate format A4 et 1/3 A4 montés sur des panneaux tapissés en textile. Sur commande on peut fabriquer des combinaisons différents formats de cases (A4, A5 et triptyques).

IT | Espositore porta depliant
Porta depliant A4 o 1/3 A4 montati su una cornice in alluminio anodizzato naturale. Su richiesta possono essere prodotti con espositori miscelati (A5, A4, 1/3 A4). Un cartello di indicazione può essere messo sulla parte superiore.

GB | Wall and floor announcement boards
Methacrylate trays DIN A4 and 1/3 A4 mounted on aluminium anodised silver frame felt announcement boards. Special order boards with different trays in different formats (A4 and A5 and brochures) can be manufactured.

DE | Prospekthalter mit fu
Acryl-Prospekthalter DIN A4 und 1/3 A4, die an eloxiertem Aluminium-Rahmen mit verchromtem Fu und schwarzem Sockel Filz-Pinntafeln befestigt werden. Auf Anfrage knnen Kombinationen von verschiedenen Fachformaten hergestellt werden.

PO | Expositor de parede e com pé
Porta folhetos de acrílico DIN A4 e 1/3 DIN A4, aplicados sobre um quadro de anúncios forrado, com aro em alumínio anodizado na cor prata mate. Por orçamento podem fabricar-se combinações com diferentes formatos de porta folhetos (A4, A5 e tríptico).

A
T

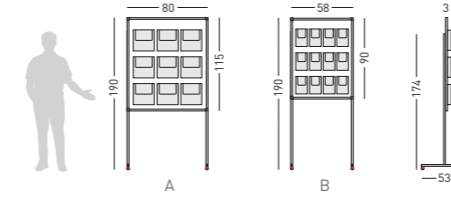

A	840/TG	190	115 x 80	3	9 - A4
B	840/TP	190	90 x 58	3	12 - 1/3 A4



B
delta

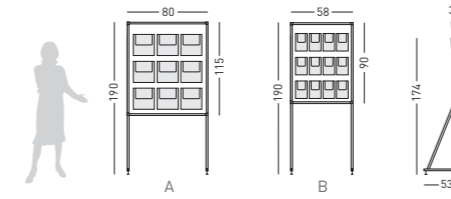

A	840/DG	190	115 x 80	3	9 - A4
B	840/DP	190	90 x 58	3	12 - 1/3 A4



C
tripod

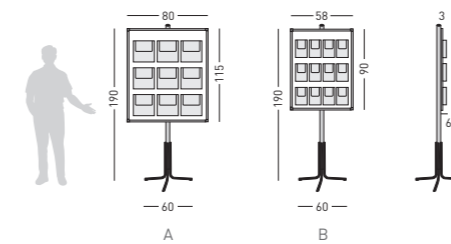

A	840/SG	190	115 x 80	3	9 - A4
B	840/SP	190	90 x 58	3	12 - 1/3 A4



D
quadra

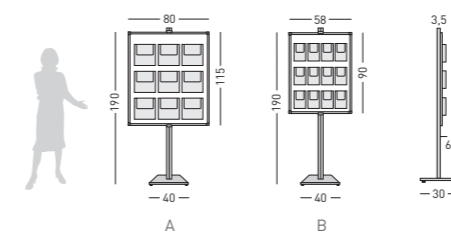

A	840/QG	195	115 x 80	3,5	9 - A4
B	840/QP	195	90 x 58	3,5	12 - 1/3 A4



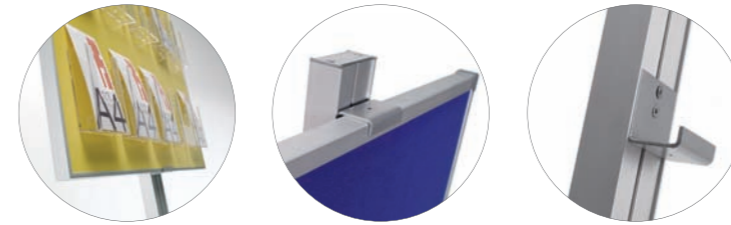

* Rótulo no incluido, ver pág. 283
* Sign not included, see pg. 283

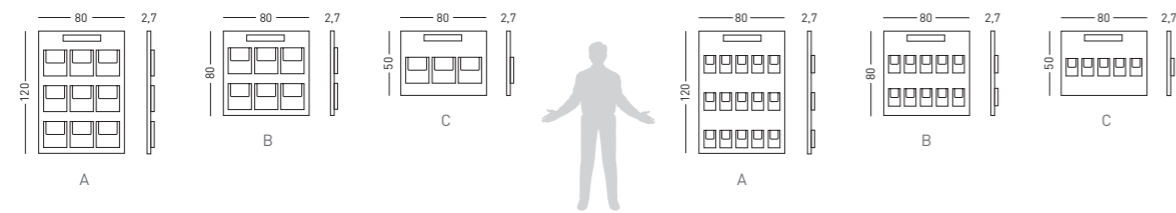

	Color	Height	Width	Depth	Capacity
A	8400/1	120	80	2,7	9 - A4
B	8400/2	80	80	2,7	6 - A4
C	8400/3	50	80	2,7	3 - A4
D	8300/1	120	80	2,7	15 - 1/3 A4
E	8300/2	80	80	2,7	10 - 1/3 A4
F	8300/3	50	80	2,7	5 - 1/3 A4

ES | Expositores "Soft"

La gama de expositores está disponible en formato mural en 3 tamaños y 2 formatos de portafolletos a elegir: DIN A4 y 1/3 DIN A4. Gracias a las múltiples combinaciones son el complemento ideal para el equipamiento de oficinas, recepciones, halls, etc...

FR | Présentoirs "Soft"

Gamme de présentoir sur piétement mural, disponible en 3 dimensions et deux formats de porte brochure A4 et 1/3 de A4. Créez votre composition pour une information visible dans les halls, couloirs, accueils...

IT | Espositori "Soft"

La gamma di espositori è disponibile a parete in 3 dimensioni e 2 formati tra cui scegliere Portafolletto: A4 e 1/3 di A4. Grazie alle multiple combinazioni sono il complemento perfetto per le apparecchiature per ufficio, reception, halls ...

GB | Announcement board "Soft"

Range of board wall fixation, available in 3 different sizes and 2 of document holder, A4 and 1/3 of A4. This is the ideal product for hall, building entrance...

DE | Prospektregal "Soft"

Das Sortiment der Aussteller auf Fuß Quadra ist im Wandformat in 3 Größen und 2 Prospektaufsteller Ausführungen verfügbar A4 und 1/3 A4. Mit mehreren Kombinationen sind die perfekte Ergänzung für Bürogeräte, Rezeption, Halle...

PO | Expositores "Soft"

A gama de expositores está disponível para colocação na parede em 3 tamanhos e 2 formatos de porta folhetos para eleger: DIN A4 e 1/3 de DIN A4. Graças às múltiplas combinações, são o complemento ideal para equipar escritórios, recepções, halls,...



* Rótulo no incluido, ver pág. 283
* Sign not included, see pg. 283



* Tablero no incluido
* Board not included

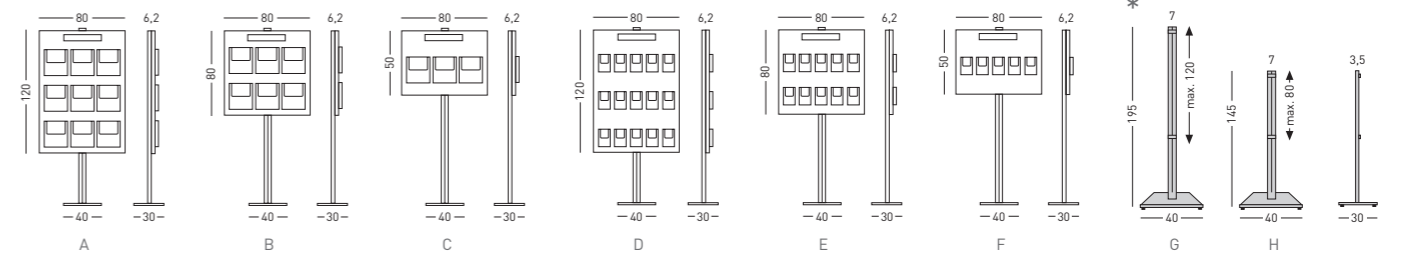

	Color	Height	Width	Depth	Capacity	
A	8400/1/P	195	120	80	6,2	9 - A4
B	8400/2/P	195	80	80	6,2	6 - A4
C	8400/3/P	195	50	80	6,2	3 - A4
D	8300/1/P	195	120	80	6,2	15 - 1/3 A4
E	8300/2/P	195	80	80	6,2	10 - 1/3 A4
F	8300/3/P	195	50	80	6,2	5 - 1/3 A4
G	Q/810/A	195	30	40	7	7 x 3,5
H	Q/810/B	145	30	40	7	7 x 3,5

ES | Expositores "Soft" con soporte

La gama de expositores está disponible en formato con soporte "Quadra" en 3 tamaños y 2 formatos de portafolletos a elegir: DIN A4 y 1/3 DIN A4. Gracias a las múltiples combinaciones son el complemento ideal para oficinas, recepciones, halls, etc...

FR | Présentoir "Soft" avec support

Gamme de présentoir sur piétement "Quadra", disponible en 3 dimensions et deux formats de porte brochure A4 et 1/3 de A4. Créez votre composition pour une information visible dans les halls, couloirs, accueils...

IT | Espositori "Soft" con supporto

la gamma degli espositori con supporto "Quadra", è disponibile a parete in 3 dimensioni e 2 formati tra cui scegliere Porta fogli: A4 e 1/3 di A4. Con combinazioni multiple sono la combinazione perfetta per le apparecchiature per ufficio, reception, sale...

GB | Announcement "Soft" with support

Range of board on "Quadra" stand, available in 3 different sizes and 2 of document holder, A4 and 1/3 of A4. This is the ideal product for hall, building entrance...

DE | Prospektregal "Soft" auf Fuß

Das Sortiment der Aussteller auf Fuß "Quadra" ist im Wandformat in 3 Größen und 2 Prospektaufsteller Ausführungen verfügbar A4 und 1/3 A4. Mit mehreren Kombinationen sind die perfekte Ergänzung für Bürogeräte, Rezeption, Halle...

PO | Expositores "Soft" com suporte

A gama de expositores com suporte "Quadra", está disponível em 3 tamanhos e 2 formatos de porta folhetos para eleger: DIN A4 e 1/3 de DIN A4. Graças às múltiplas combinações, são o complemento ideal para equipar escritórios, recepções, halls,...

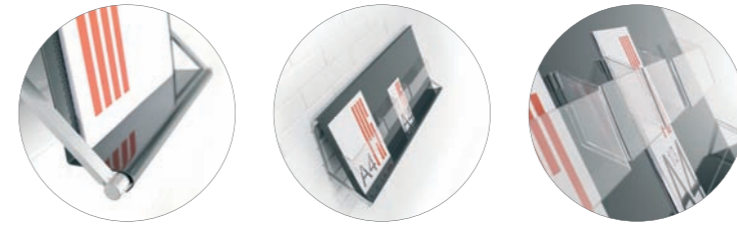

168

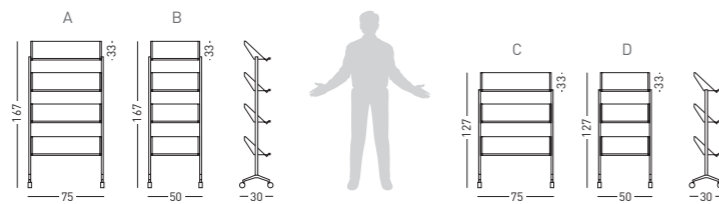

	A	B	C	D
A	LO/150/3/P	167 x 75	33 x 75	12 - A4
B	LO/150/2/P	167 x 50	33 x 50	8 - A4
C	LO/110/3/P	127 x 75	33 x 75	9 - A4
D	LO/110/2/P	127 x 50	33 x 50	6 - A4

- Chapa perforada
- Perforated metal

ES | Expositor "Look"

Expositor Look compuesto de estructura metálica con ruedas y estantes metálicos de chapa perforada, ranurada o screen (tèxtil) con capacidad para 2 ó 3 DIN A4. La versión ranurada permite incorporar unos cajetines de metacrilato en formatos Din A4 y tríptico.

GB | "Look" display

Display composed of a metallic structure on castors, with shelves in perforated, grooved metal or fabric. Capacity of 2 or 3 A4. A methacrylat tray can be added on the grooved version in size A4 or 1/3 of A4.

FR | Présentoir "Look"

Présentoir composé d'une structure métallique sur roulettes et d'étagères en métal perforé, rainuré, ou en tissu. Capacité de 2 ou 3 A4. Possibilité d'ajouter des protège-documents en méthacrylate sur la version rainurée, aux formats A4 et triptique.

DE | Aussteller "Look"

Aussteller-Metall-Struktur bestehend aus Metallregale mit Rädern und Lochblech, geschlitz oder Bildschirm (Stoffe) mit einer Kapazität für 2 oder 3 A4. Die geschlitzene Version erlaubt Ihnen, Methacrylat-Prospektaufsteller in A4 und Broschüre zu übernehmen.

IT | Espositore "Look"

Espositore Look composto da struttura metallica con ruote e scaffali metallici di lamiera perforata, screen (tela) o scanalature con capacità per 2 o 3 Din A4. La versione scanalata permette di incorporare cassetti di metacrilato nei formati Din A4 e triptici.

PO | Expositor "Look"

Expositor Look, composto por uma estrutura metálica com rodas e prateleiras metálicas em chapa perfurada, ranhurada ou screen (lona), com capacidade para 2 ou 3 DIN A4. A versão ranhurada permite incorporar porta folhetos em acrílico no formato A4 e tríptico.

169

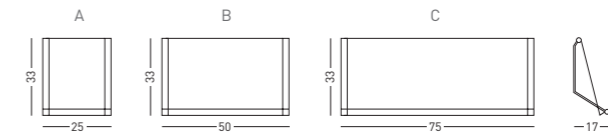

	A	B	C	
A	LOM/1/P	33 x 25	17	1 - A4
B	LOM/2/P	33 x 50	17	2 - A4
C	LOM/3/P	33 x 75	17	3 - A4

- Chapa perforada
- Perforated metal

ES | Expositor "Look" mural

Expositor Look compuesto de estructura metálica y estantes metálicos de chapa perforada, ranurada o screen (tèxtil) con capacidad para 1, 2 ó 3 DIN A4. La versión ranurada permite incorporar unos cajetines de metacrilato en formatos DIN A4 y tríptico.

GB | "Look" wall display

Display composed of a metallic structure, with shelves in perforated, grooved metal or fabric. Capacity of 1, 2 or 3 A4. A methacrylat tray can be added on the grooved version in size A4 or 1/3 of A4.

FR | Présentoir "Look" mural

Présentoir composé d'une structure métallique et d'étagères en métal perforé, rainuré ou en tissu. Capacité de 1, 2 ou 3 A4. Possibilité d'ajouter des protège-documents en méthacrylate sur la version rainurée, aux formats A4 et triptique.

DE | Aussteller "Look" wand

Aussteller-Metall-Struktur bestehend aus Metallregale mit Rädern und Lochblech, geschlitz oder Bildschirm (Stoffe) mit einer Kapazität für 2 oder 3 A4. Die geschlitzene Version erlaubt Ihnen, Methacrylat-Prospektaufsteller in A4 und Broschüre zu übernehmen.

IT | Espositore "Look" da parete

Espositore Look composto da struttura metallica e scaffali metallici di lamiera perforata, screen (tela) o scanalature con capacità per 1, 2 o 3 Din A4. La versione scanalata permette di incorporare cassetti di metacrilato nei formati Din A4 e triptici.

PO | Expositor "Look" de parede

Expositor Look, composto por uma estrutura metálica e prateleiras metálicas em chapa perfurada, screen (lona) ou chapa ranhurada com capacidade para 1, 2 ou 3 DIN A4. A versão ranhurada permite incorporar porta folhetos em acrílico no formato A4 e tríptico.

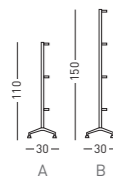
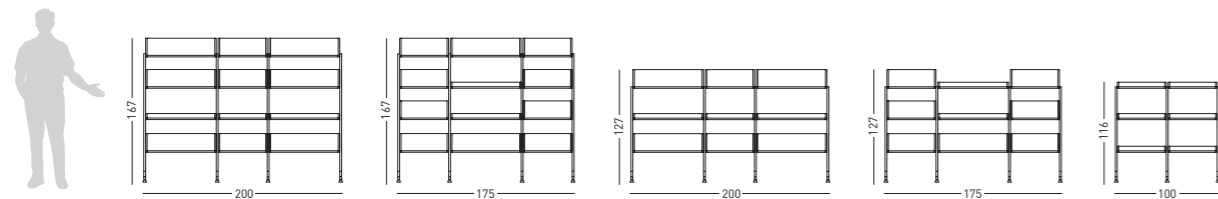

A	LO/L110	110 x 30	3
B	LO/L150	150 x 30	3

- Soporte lateral
- Lateral support

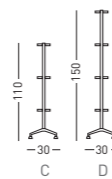

C	LO/L110/D	110 x 30	3
D	LO/L150/D	150 x 30	3

- Soporte intermedio
- Middle support

Expositor "Look" con soporte
Sistema componible de estantería y expositor "Look" compuesto de estructura metálica con ruedas y estantes metálicos de chapa perforada, ranurada o screen (tèxtil) con capacidad para 2 ó 3 DIN A4.

"Look" display
Display composed of a metallic structure on castors, with shelves in perforated, grooved metal or fabric. Capacity of 2 or 3 A4. A methacrylat tray can be added on the grooved version in size A4 or 1/3 of A4.

FR | Présentoir "Look"
Présentoir composé d'une structure métallique sur roulettes et d'étagères en métal perforé, rainuré ou en tissu. Capacité de 2 ou 3 A4. Possibilité d'ajouter des protège-documents en méthacrylate sur la version rainurée, aux formats A4 et triptique.

DE | Aussteller "Look"
Modulares System von Regal- und Display-Struktur von Metal Regale mit Rädern und durchlöchernten Blech, geschlitz oder Bildschirm (Stoffe) mit einer Kapazität für 2 oder 3 DIN A4.

IT | Espositore "Look"
Espositore Look composto da struttura metallica con ruote e scaffali metallici di lamiera perforata, screen (tela) o scanalature con capacità per 2 o 3 Din A4. La versione scanalata permette di incorporare cassetti di metacrilato nei formati Din A4 e triptico.

PO | Expositor "Look"
Expositor Look, composto por uma estrutura metálica com rodas e prateleiras metálicas em chapa perfurada, screen (lona) ou chapa ranhurada com capacidade para 2 ou 3 DIN A4. A versão ranhurada permite incorporar porta folhetos em A4 e triptico.

A
ruedas



LO/R

- ES - Kit de 2 ruedas
- GB - Set of 2 castors
- FR - Kit de 2 roulettes
- DE - 2 Rollen-Kit
- IT - Kit di 2 ruote
- PO - Kit de 2 rodas

B
niveladores



LO/N

- ES - Kit de 2 niveladores
- GB - Set of 2 jacks
- FR - Kit de 2 verins
- DE - 2 Nivellierfüße-kit
- IT - Kit di 2 livellatori
- PO - Kit de 2 niveladores

C
estante
inclinado
perforado

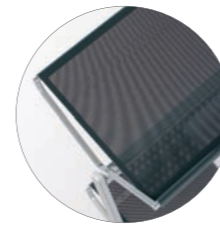

LO/2/P - 33 x 50
LO/3/P - 33 x 75

- ES - Estante inclinado perforado para 2 ó 3 DIN A4
- GB - Inclined shelf in perforated metal 2 or 3 A4
- FR - Tablette inclinée perforée 2 ou 3 A4
- DE - Metalleinlegefach, durchgelöchert für 2 oder 3 A4
- IT - Vassoio propensa perforato per 2 o 3 A4
- PO - Prateleira inclinada perfurada para 2 ou 3 A4

D
estante
inclinado



LO/2/M - 33 x 50
LO/3/M - 33 x 75

- ES - Estante metálico para 2 ó 3 DIN A4
- GB - Shelve in metal 2 or 3 A4
- FR - Tablette métallique 2 ou A4
- DE - Metalleinlegefach, mit Schlitz für 2 oder 3 A4
- IT - Vassoio metallico per 2 o 3 A4
- PO - Prateleira metálica para 2 ou 3 A4

E
estante
plano
perforado

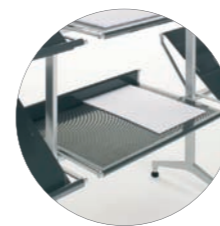

LO/2/PP - 33 x 50
LO/3/PP - 33 x 75

- ES - Estante plano perforado para 2 ó 3 Din A4
- GB - Flat shelf in perforated metal for 2 or 3 A4
- FR - Tablette plane perforée pour 2 ou 3 A4
- DE - Ebener Warenträger, durchgelöchert für 2 oder 3 A4
- IT - Scaffale piano perforato per 2 o 3 A4
- PO - Prateleira plana perfurada para 2 ou 3 A4

F
estante
plano

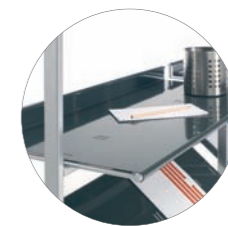

LO/2/PM - 33 x 50
LO/3/PM - 33 x 75

- ES - Estante plano para 2 ó 3 DIN A4
- GB - Flat shelf in metal for 2 or 3 A4
- FR - Tablette plane pour 2 ou 3 A4
- DE - Ebener Warenträger, mit Schlitz für 2 oder 3 A4
- IT - Scaffale piano per 2 o 3 A4
- PO - Prateleira plana para 2 ou 3 A4

G
porta
folletos



LO/A4 - 7 x 23
LO/A4/3 - 7 x 11

- ES - Portafolletos de metacrilato DIN A4 ó 1/3 DIN A4
- GB - Tray for leaflets in methacrylate size A4 or 1/3 A4
- FR - Porte-brochures en méthacrylate format A4 ou 1/3 A4
- DE - Acryl-Prospekhalter A4 oder 1/3 A4
- IT - Portafogli in metacrilato A4 o 1/3 A4
- PO - Porta folhetos em acrílico DIN A4 ou 1/3 DIN A4

- Para estante inclinado (D)
- For inclined shelf (D)



	↑	↔	
A	834/TC/1	80	51 x 51
B	834/TC/2	150	51 x 51
C	834/TC/3	185	51 x 51
		↔	
D	834/TC/L	51 x 51	
E	834/C		

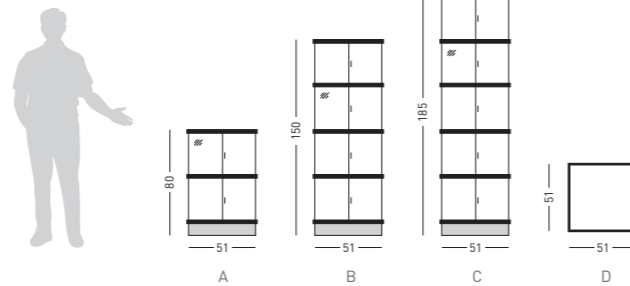

ES | Vitrina expositora cuadrada

Vitrina expositora cuadrada 51 x 51 cm. de cristal templado de 4 mm. fabricada con perfiles intermedios (entre estantes). Las puertas son correderas, pudiendo abrir sólo el estante deseado. Sistema de montaje fácil y rápido, disponible en 3 alturas.

GB | Square showcase

Square glass showcase 51 x 51 cm. made of tempered crystal 4 mm with intermediate profiles (between shelves). Sliding doors, being possible to open only the wished shelf. Fast and easy-mounted system, available in 3 heights.

FR | Vitrine carrée

Vitrine carrée 51 x 51 cm. en verre trempé (4 mm) chaque étage est monté sur un support en ABS noir. Les portes coulissent, pour ouvrir séparément l'étage souhaité. Système de montage facile et rapide, disponible en 3 dimensions.

DE | Glasvitrine

Quadrat-förmige Säulenvitrine 51 x 51 cm. Die Schiebetüren sind aus 4 mm Glas. Wenn es erwünscht wird, kann man nur den gewünschten Fachboden öffnen. Einfache, schnellere Aufbau. In 3 Höhen verfügbar.

IT | Vetrina espositiva quadrata

Vetrina espositiva quadrata 51 x 51 cm. In cristallo temperato da 4 mm. fabbricata con profili intermedi (tra le mensole). Ante scorrevoli per aprire solo la parte desiderata. Sistema di montaggio molto facile disponibile in 3 altezze.

PO | Vitrine expositora quadrada

Vitrine expositora quadrada com 51 x 51 cm. em vidro temperado de 4 mm., com perfis intermediários (entre prateleiras). As portas são de correr, podendo abrir apenas a prateleira desejada. Sistema de montagem fácil e rápido, disponível em 3 alturas.



	↑	↔	
A	834/TR/1	80	36 x 72
B	834/TR/2	150	36 x 72
C	834/TR/3	185	36 x 72
		↔	
D	834/TR/L	36 x 72	
E	834/C		

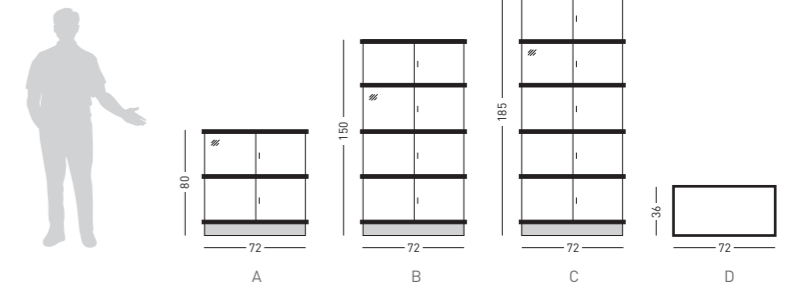

ES | Vitrina expositora rectangular

Vitrina expositora rectangular 36 x 72 cm. de cristal templado de 4 mm fabricada con perfiles intermedios (entre estantes). Las puertas son correderas, pudiendo abrir sólo el estante deseado. Sistema de montaje fácil y rápido, disponible en 3 alturas.

GB | Rectangular showcase

Rectangular glass showcase 36 x 72 cm. made of tempered crystal 4 mm. with intermediate profiles (between shelves). Sliding doors, being possible to open only the wished shelf. Fast and easymounted system, available in 3 heights.

FR | Vitrine rectangulaire

Vitrine carrée 36 x 72 cm. en verre trempé (4 mm) chaque étage est monté sur un support en ABS noir. Les portes coulissent, pour ouvrir séparément l'étage souhaité. Système de montage facile et rapide, disponible en 3 dimensions.

DE | Glasvitrine

Rechteckige Säulenvitrine 36 x 72 cm., Die Schiebetüren sind aus 4 mm. Sicherheitsglas. Einfache, schnellere Aufbau. Es sind 3 Höhen verfügbar. Auf Anfrage kann die Referenz 185 cm. hoch mit Einbauleuchten (3 x 12 v/20w) geliefert werden. Mit Glasfächern und Untersockel.

IT | Vetrina espositiva rettangolare

Vetrina espositiva rettangolare 36 x 72 cm. In cristallo temperato da 4 mm. fabbricata con profili intermedi (tra le mensole). Ante scorrevoli per aprire solo la parte desiderata. Sistema di montaggio molto facile disponibile in 3 altezze.

PO | Vitrine expositora rectangular

Vitrine expositora rectangular com 36 x 72 cm. em vidro temperado de 4 mm., com perfis intermediários (entre prateleiras). As portas são de correr, podendo abrir apenas a prateleira desejada. Sistema de montagem fácil e rápido. Disponível em 3 alturas.

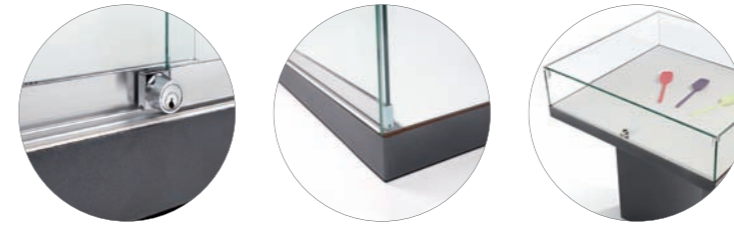
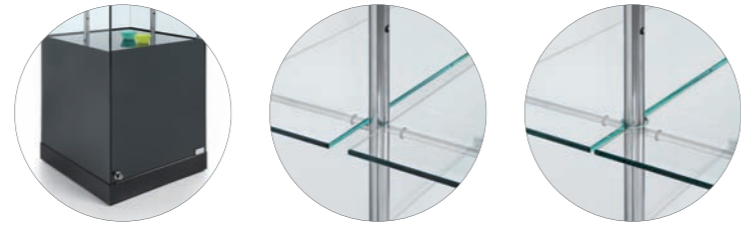

174



175

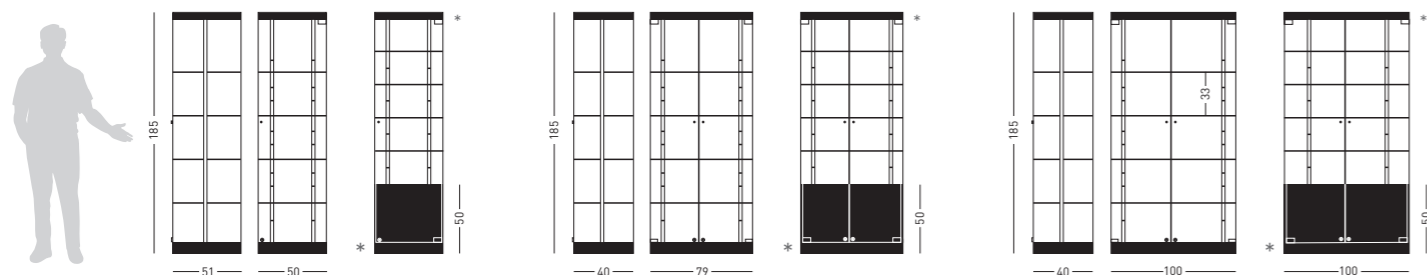

		Shelf	LED		
A	VI/50/T	50 x 51	182	4	1
B	VI/80/T	40 x 80	182	4	2
C	VI/100/T	40 x 100	182	4	2

* Templated

VNL/50	VI/SE/50/T
VNL/80	VI/SE/80/T
VNL/100	VI/SE/100/T

* Buc vinil
** Optional shelf templated



	LED	
VI/L	100	2

Kit LED (1W) optional

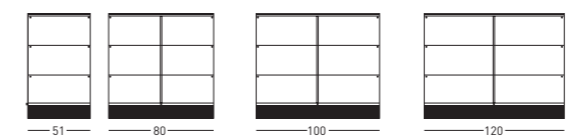

	Shelf		
VIM/80/T	51 x 80	85	2
VIM/100/T	51 x 100	85	2
VIM/120/T	51 x 120	85	2

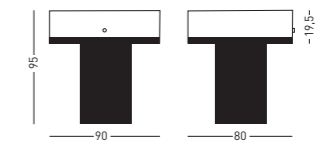

VIM/T	80 x 90	95
--------------	---------	----

ES | Vitrina cristal templado

Gama de vitrinas de pié con base y sobre de plancha. Cristal de 6 mm templado y puerta con cerradura. Montantes de acero inox. Hasta 6 estantes regulables en altura. Iluminación Led. Disponible en varias medidas y opción buc vinilado en la parte inferior.

FR | Vitrites en verre trempé

Gamme de vitrines sur pied et plaque en métal. En verre trempé de 6 mm et avec serrure. Goujons en acier inoxydable. Jusqu'à 6 tablettes réglables en hauteur. Illumination avec Led. Disponible en différentes dimensions option couleur avec vinyle sur la base.

IT | Veterinette in cristallo temerato

Gamma di vetrinate da terra con base e top in ferro. Cristallo di 6 mm, temperato e porta con serratura. Montanti in acciaio inox. Fino a sei ripiani regolabili in altezza. Illuminazione Led. Disponibile in varie misure e opzione rivestita in vinile sulla parte inferiore.

ES | Vitrina cristal templado

Gama de vitrinas de pié con base y sobre de plancha. Cristal de 6 mm templado y puerta con cerradura. Montantes de acero inox. Hasta 6 estantes regulables en altura. Iluminación Led. Disponible en varias medidas y opción buc vinilado en la parte inferior.

FR | Vitrites en verre trempé

Gamme de vitrines sur pied et plaque en métal. En verre trempé de 6 mm et avec serrure. Goujons en acier inoxydable. Jusqu'à 6 tablettes réglables en hauteur. Illumination avec Led. Disponible en différentes dimensions option couleur avec vinyle sur la base.

IT | Veterinette in cristallo temerato

Gamma di vetrinate da terra con base e top in ferro. Cristallo di 6 mm, temperato e porta con serratura. Montanti in acciaio inox. Fino a sei ripiani regolabili in altezza. Illuminazione Led. Disponibile in varie misure e opzione rivestita in vinile sulla parte inferiore.

GB | Showcase with tempered glass

Range of showcases with top and bottom made of steel. The tempered glass is 6 mm thick has a lock on the door. Structure is Stainless steel. Up to 6 height adjustable shelves. Led Lighting. Available in various sizes, vinylated option at the bottom.

DE | Sortiment von Ausstellungsvitrinen

Sortiment von Ausstellungsvitrinen, unter- und Oberseite aus Stahlblech, gedämpftes 6mm Glas und verschliessbar. Träger aus Edelstahl, 6 höhenverstellbare Regale. Bleuchtung durch LED. Erhältlich in verschiedenen Abmessungen und als Option Vinyl im unteren Bereich.

PO | Vitrine vidro temperado

Gama de vitrinas de pé com base. Vidro de 6 mm temperado e porta com fechadura. Pilares em aço inox. Até 6 prateleiras em altura. Iluminação LED. Disponível em várias medidas e com opção de móvel com vinil publicitário na parte inferior.

GB | Showcase with tempered glass

Range of showcases with top and bottom made of steel. The tempered glass is 6 mm thick has a lock on the door. Structure is Stainless steel. Up to 6 height adjustable shelves. Led Lighting. Available in various sizes, vinylated option at the bottom.

DE | Sortiment von Ausstellungsvitrinen

Sortiment von Ausstellungsvitrinen, unter- und Oberseite aus Stahlblech, gedämpftes 6mm Glas und verschliessbar. Träger aus Edelstahl, 6 höhenverstellbare Regale. Bleuchtung durch LED. Erhältlich in verschiedenen Abmessungen und als Option Vinyl im unteren Bereich.

PO | Vitrine vidro temperado

Gama de vitrinas de pé com base. Vidro de 6 mm temperado e porta com fechadura. Pilares em aço inox. Até 6 prateleiras em altura. Iluminação LED. Disponível em várias medidas e com opção de móvel com vinil publicitário na parte inferior.

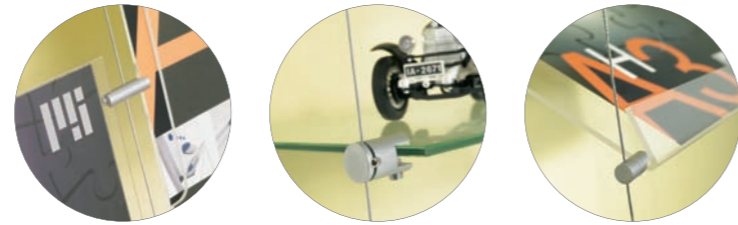

A
cable

pg. 178 - 179

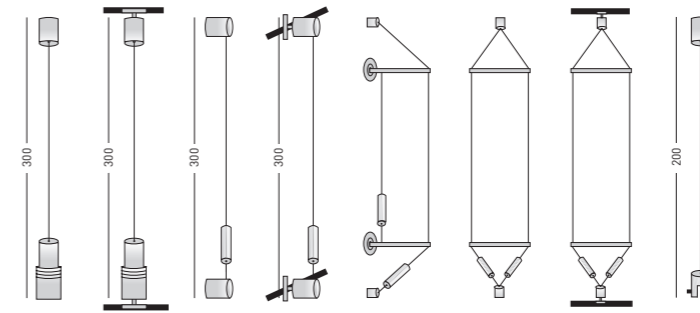

ES | Cables y tensores

Conjunto formado por 1 pieza fija a techo, pared o rail en la parte superior, 1 cable de acero de 3 m. y 1 pieza tensora inferior que se fija a suelo, pared o carril.

FR | Câbles

Kit composé de 1 support fixation au plafond, mur ou rail, 1 câble en acier 3 m., et un tendeur inférieur pour une fixation au sol, mur ou rail.

IT | Cavi e tenditori

Composto da 1 pezzo fissato al soffitto, a parete o parte superiore, 1 cavo in acciaio 3 m. e 1 tenditore inferiore che è collegato a pavimento, a parete/rotail.

GB | Cables

Cables can be fitted to suit all requirements – for wall to wall, floor to ceiling. Length: 3 m. Ceiling-mounted: the cables secured to an end stop.

DE | Drahtseil

An der Decke, Wand oder Schiene gesichertes Drahtseil 3 m. lang, am Boden werden die Drahtseile von dem Spanner gehalten (Wand oder Schiene).

PO | Cabos e tendores

Conjunto formado por 1 peça fixa ao tecto, parede ou carril na parte superior, 1 cabo em aço de 3 m. e 1 peça tensora inferior, que se fixa ao chão, parede ou carril.



B
pinzas

pg. 178 - 179



ES | Pinzas de sujeción

Pinzas mediante las cuales se sujetan las carpetas, estantes o cubos de metacrilato al cable tensor. Disponibles en múltiples formatos según su aplicación.

FR | Pincés de fixation

Pincés de fixation permettant la liaison du câble avec les pochettes porte-visuel, tablettes ou boîtes. Disponibilité: pince simple ou double, fixes ou giratoires.

IT | Pinze di sostenimento

Pinze mediante le quali si sostengono cartelle, scaffali, cubi metacrilato al cavo di tensione. Disponibile in diversi formati secondo la vostra applicazione.

GB | Support grips

Single sided or double sided support grips to hold methacrylate panels, shelves or boxes. Either fixed or rotating.

DE | Klemmträger

Klemmträger für die Befestigung von Prospektablage, Regale oder Kästen zum Edelstahlkabel. Doppelseitige oder einseitiger und fest- oder drehbar.

PO | Pinças de fixação

Pinças mediante as quais se penduram as capas, prateleiras ou cubos em acrílico, ao cabo tensor. Disponíveis em múltiplos formatos, mediante cada utilização.



ES - Carpetas DIN
GB - Panels DIN
FR - Pochetes DIN
DE - Tafeln/shilder
IT - Pannelli DIN
PO - Capas DIN

ES - Estante plano
GB - Plane shelf
FR - Tablette plane
DE - Flache regalboden
IT - Mensola piana
PO - Prateleira plana

ES - Estante inclinado
GB - Inclined shelf
FR - Tablettes inclinées
DE - Schiefe regalboden
IT - Mensola inclinata
PO - Prateleira inclinada

ES - Cubos
GB - Boxes
FR - Boîtes
DE - Kästen
IT - Cubi
PO - Cubos

ES | Sistema de cables y tensores

Sistema de información de cables y tensores multifuncional. Mediante cables, carpetas de metacrilato y pinzas se puede componer el diseño deseado. Disponible en varios formatos y acabados.

FR | Système de cable et pochette

Information, publicité ou décoration sur câble acier, pincés, tablettes et pochettes en méthacrylate. Composez votre vitrine a votre image.

IT | Sistema di cavi e tenditori

Moderno e pratico sistema di informazione con cavi che permette di montare velocemente e facilmente porta informazioni e cubi in metacrilato; ideale per negozi, esposizioni e franchising.

GB | Cable and tension system

Multifunctional cable and tension displaying system. You can create your own design by disposing cables, methacrylate folders and pinners from the ceiling to the floor, or ceiling-suspended. Available in different formats and finishes.

DE | Edelstahlseilsystem

Multifunktionales Seilsystem, welches durch seine Seile, Haken und Zangen eine individuellen Gestaltung ermöglicht. Erhältlich in verschiedenen Ausführungen.

PO | Sistema de cabos e tensores

Sistema de informação com cabos e tensores multifuncionais, através de cabos, capas em acrílico e pinças, que permite compor o design desejado. Disponível em vários formatos e acabamentos.

C
rail

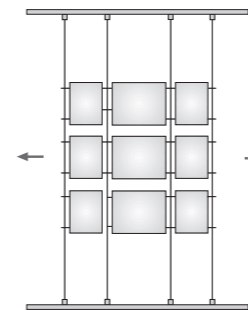

2001/C	2,5 x 100
2002/C	2,5 x 200
2003/C	2,5 x 300

ES | Rail de desplazamiento

Perfil de aluminio anodizado. Se atornilla a techo y/o suelo y/o pared, y en su carril se fija el tensor. El tensor permite desplazarse a derecha e izquierda.

FR | Rail aluminium

Finition aluminium anodisé. Fixation au plafond et/ou au sol et/ou au mur, vis fournie. Il permet de déplacer librement l'ensemble des câbles.

IT | Guida di movimento

Profilo in alluminio anodizzato. E' avvitata al pavimento o al soffitto e nella sua corsia si fissa al tenditore. Il tenditore permette lo scorrimento verso sinistra/destra.

GB | Aluminium rail

Anodised aluminium finish. Screw fixing into ceiling and/or floor and/or wall. The tensor allows the sliding to the left or right.

DE | Aluminiumschiene

An der Decke und/oder Boden und/oder Wand befestigte silber eloxierte Aluminiumschiene. Das Drahtseil kann in der Schiene zur gewünschten Position.

PO | Carril em alumínio

Perfil em alumínio anodizado. É aparafusado ao chão, ao tecto ou à parede, e nele se fixa o tensor. O tensor permite ser deslocado para a direita ou esquerda.

D

carpetas

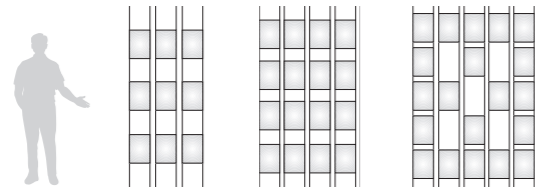

- ES - Carpetas
- GB - Panels
- FR - Pochetes
- DE - Tafeln/shilder
- IT - Pannelli
- PO - Capas

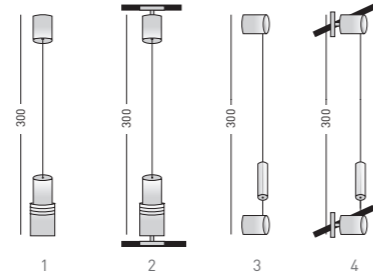
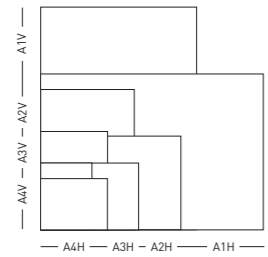

A	?
ST/A4/V	30 x 23,5 A4 V
ST/A4/H	21 x 32,5 A4 H
ST/A3/V	42 x 32,5 A3 V
ST/A3/H	30 x 44,5 A3 H
ST/A2/V	59 x 42 A2 V
ST/A2/H	42 x 59 A2 H
ST/A1/V	85 x 59 A1 V
ST/A1/H	60 x 84 A1 H

1	2003/TS	300
2	2003/TSC	300
3	2003/MM	300
4	2003/MMC	300
↑		
B	2000/2	0,4
C	2000/3	0,4

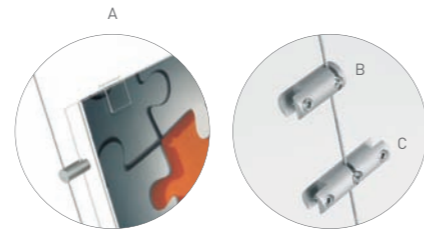

178

F

estante plano

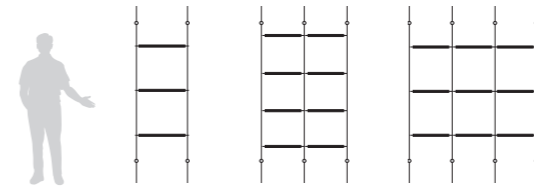

- ES - Estante plano
- GB - Plane shelf
- FR - Tablette plane
- DE - Flache regalboden
- IT - Mensola piana
- PO - Prateleira plana

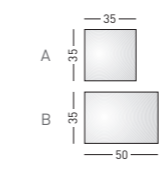
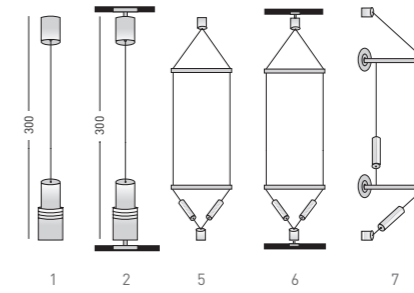

1	2003/TS	300
2	2003/TSC	300
5	2033/TS	300
6	2033/TSC	300
7	2023/MM	300
↑		
C	2000/4	0,8
D	2000/8	0,8

A	ST/ES/1	35 x 35	0,5
B	ST/ES/2	35 x 50	0,5

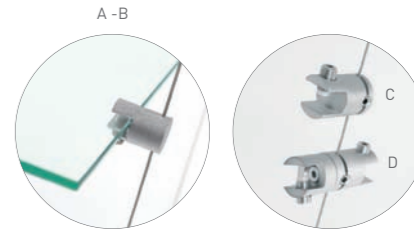

179

E

cabos

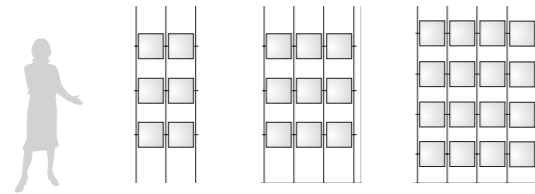

- ES - Cubos
- GB - Boxes
- FR - Boîtes
- DE - Kasten
- IT - Cubi
- PO - Cubos

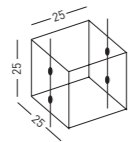
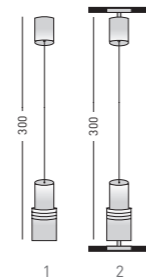

A	?	kg
CUB/25	25 x 25	2 kg

1	2003/TS	300
2	2003/TSC	300
↑		
B	2000/9	0,8
C	2000/10	0,8

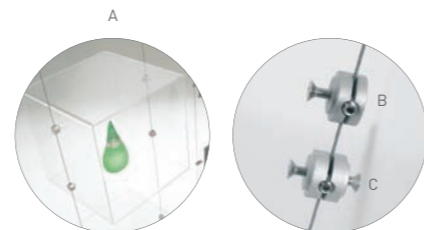

G

estante inclinado

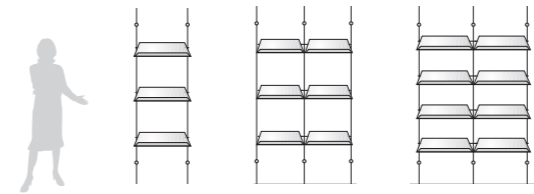

- ES - Estante inclinado
- GB - Inclined shelf
- FR - Tablettes inclinées
- DE - Schiefe regalboden
- IT - Mensola inclinata
- PO - Prateleira inclinada

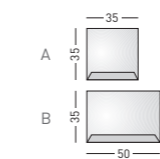
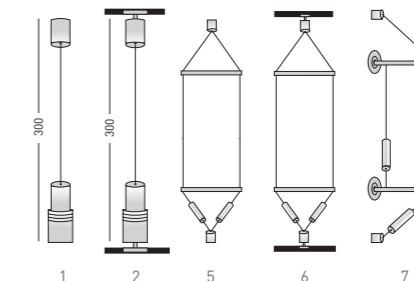

1	2003/TS	300
2	2003/TSC	300
5	2033/TS	300
6	2033/TSC	300
7	2023/MM	300
↑		
C	2000/5	0,4
D	2000/6	0,4

A	ST/EI/1	35 x 35	0,2
B	ST/EI/2	35 x 50	0,2

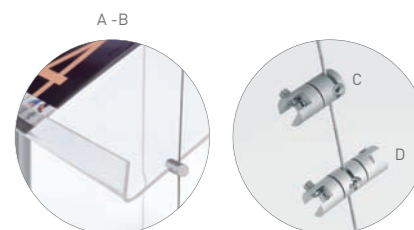

E-CLIP

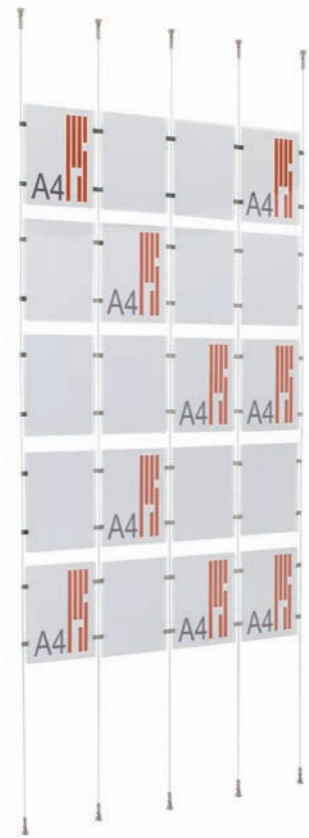
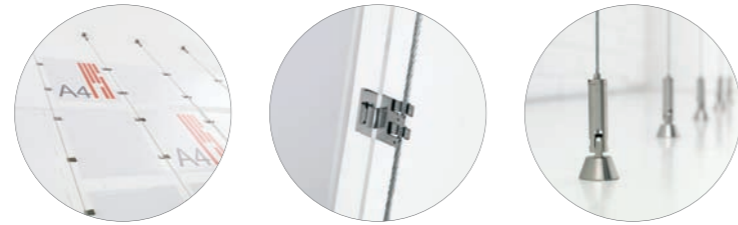

A kit

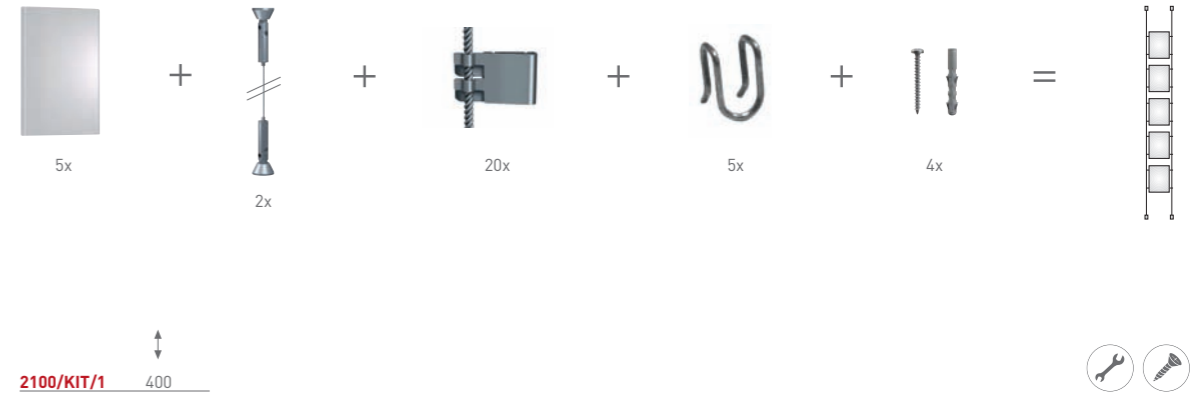

B cable



C pinza



D carpeta

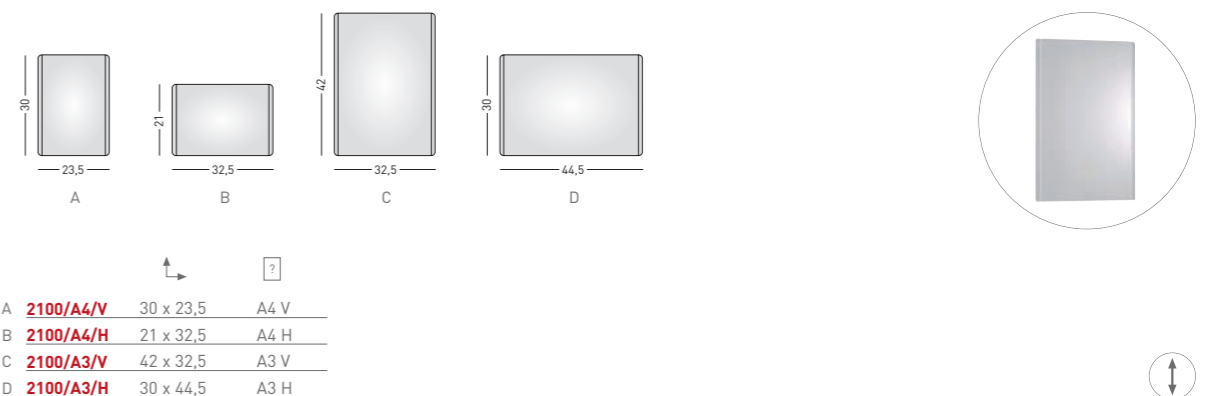

^{ES} | Sistema de cables y tensores "E-CLIP"
Sistema de cables y tensores con carpetas de metacrilato transparente con nuevo sistema E-CLIP que permite intercambiar y mover de arriba/abajo las carpetas sin necesidad de herramientas y en pocos segundos.

^{FR} | Systeme de cable et pochette "E-CLIP"
Information, publicité ou décoration sur câble en acier et pinces. Le nouveau système de pinces E-CLIP permet de moduler facilement et sans outils votre composition.

^{IT} | Sistema di cavi e tenditori "E-CLIP"
Sistema di cavi e tenditori con kit acrilico trasparente nuovo E-CLIP che consente la condivisione e lo spostamento su e giù per le cartelle e senza attrezzi in pochi secondi.

^{GB} | "E-CLIP" cable and tension system
Multifunctional cable and tension display system. Thanks to the new grip E-CLIP it will be easy and fast to move your composition without need of special tools.

^{DE} | Edeltahseilsystem "E-CLIP"
Edeltahseilsystem mit transparenten Acryl-Schildern und das neue E-Clip. Dieses System ermöglicht den Austausch der Schildern und die Bewegung nach oben und unten ohne Werkzeuge und in wenigen Sekunden.

^{PO} | Sistema de cabos e tensores "E-CLIP"
Sistema de cabos e tensores com capas em acrílico transparente, com o novo sistema E-CLIP, que permite trocar e mover para cima e para baixo as capas, sem necessidade de ferramentas e em poucos segundos.

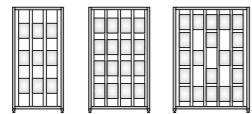

ES - Carpetas
GB - Panels
FR - Pochetes
DE - Tafeln/shilder
IT - Pannelli
PO - Capas

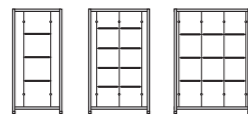

ES - Estante plano
GB - Plane shelf
FR - Tablette plane
DE - Flache regalboden
IT - Mensola piana
PO - Prateleira plana



ES - Estante inclinado
GB - Inclined shelf
FR - Tablettes inclinées
DE - Schiefe regalboden
IT - Mensola inclinato
PO - Prateleira inclinada

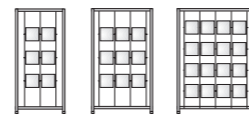

ES - Cubos
GB - Boxes
FR - Boîtes
DE - Kasten
IT - Cubi
PO - Cubos

ES | Bastidor móvil "TEN"

Sistema de cables sobre bastidor "Ten" fabricado en aluminio anodizado y pie "Y2" de fundición, provisto de ruedas o niveladores, que permite de manera rápida montar y desplazar el conjunto al espacio deseado. Ideal para escaparates, exposiciones, etc...

FR | Cadre auto-portant "TEN"

Système auto-portant en aluminium anodisé avec piétement "Y2" en fonte, avec roulettes ou verins, mobilité totale et configuration modulable (cables, pochettes, tablettes...).

IT | Telaio "TEN" in alluminio

Sistema di cavi su telaio "Ten" fabbricato in alluminio anodizzato e base "Y2" in ghisa, provvisto di ruote o livellatori, rapidamente montabile e smontabile per poter essere adattato facilmente allo spazio desiderato. Ideale per vetrine, esposizioni, ecc.

GB | Aluminium frame "TEN"

Display cabling system in anodized aluminium with cast-iron "Y2" support, castors or jacks, total mobility and modular layout (cables, pockets, trays...)

DE | Aluminium-Fahrgestell "TEN"

Edelstahlsystem Fahrgestell "TEN" auf einem Guss-Fuß und in silber eloxiertem Aluminium hergestellt. Ausgestattet mit Rollen oder Nivelierfüße, die schnell montierbar sind und ermöglichen die Bewegung zu dem gewünschten Platz.

PO | Bastidor "TEN" em alumínio

Sistema de cabos colocados num bastidor "Ten", fabricado em alumínio anodizado e pé "Y2", com rodas ou niveladores, que permite montar e deslocar de uma forma rápida e simples, o expositor inteiro. Ideal para montras, exposições, etc.

A
bastidor

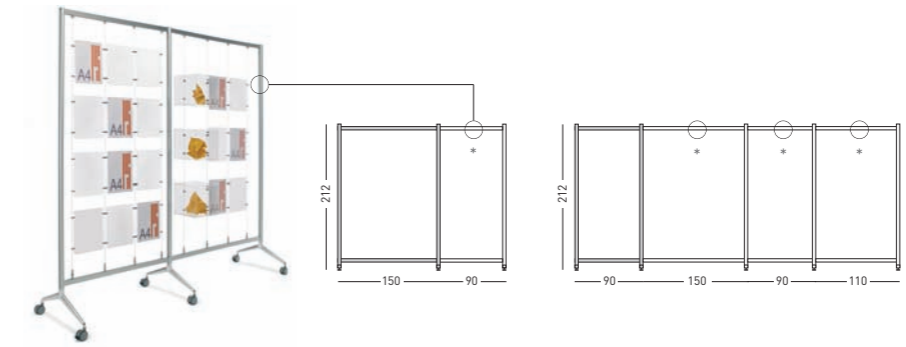
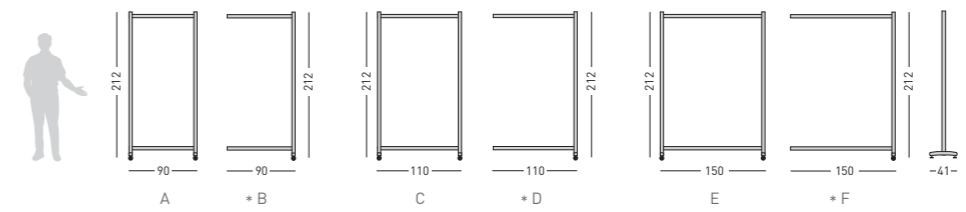

	1	2
A	TN/90/R 212 x 90 5 3	TN/90/N 212 x 90 5 3
*B	TN/90/XF/R 212 x 90 5 3	TN/90/XF/N 212 x 90 5 3
C	TN/110/R 212 x 110 5 4	TN/110/N 212 x 110 5 4
*D	TN/110/XF/R 212 x 110 5 4	TN/110/XF/N 212 x 110 5 4
E	TN/150/R 212 x 150 5 5	TN/150/N 212 x 150 5 5
*F	TN/150/XF/R 212 x 150 5 5	TN/150/XF/N 212 x 150 5 5



B
tensor

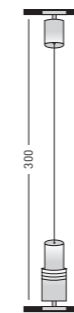

2003/TSC 300



C
pinzas



2000/2	0,4	2000/4	0,8	2000/5	0,4
2000/3	0,4	2000/8	0,8	2000/6	0,4

* Para carpetas
* For panels

* Para estante plano
* For plane shelf

* Para estante inclinado
* For inclined shelf



E
TEN
carpetas

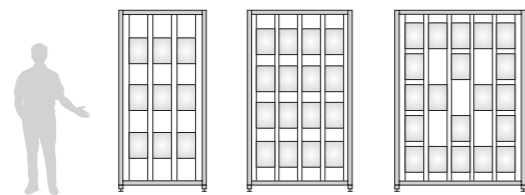

- ES - Carpetas
- GB - Panels
- FR - Pochetes
- DE - Tafeln/shilder
- IT - Pannelli
- PO - Capas

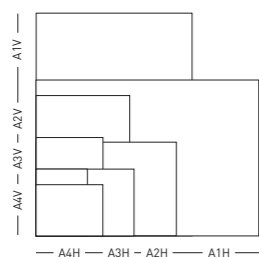

A	kg	?
ST/A4/V	30 x 23,5	A4 V
ST/A4/H	21 x 32,5	A4 H
ST/A3/V	42 x 32,5	A3 V
ST/A3/H	30 x 44,5	A3 H
ST/A2/V	59 x 42	A2 V
ST/A2/H	42 x 59	A2 H
ST/A1/V	85 x 59	A1 V
ST/A1/H	60 x 84	A1 H

1	2003/TSC	300
---	-----------------	-----

B	2000/2	0,4
C	2000/3	0,4

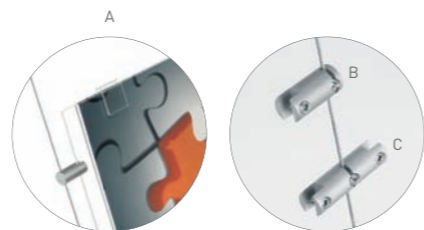

F
TEN
estante
plano

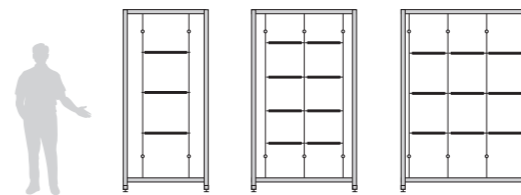

- ES - Estante plano
- GB - Plane shelf
- FR - Tablette plane
- DE - Flache regalboden
- IT - Mensola piana
- PO - Prateleira plana

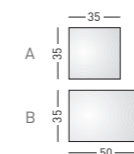

A	ST/ES/1	35 x 35	0,5
B	ST/ES/2	35 x 50	0,5



1	E/EST/TEN	300
---	------------------	-----

C	2000/4	0,8
D	2000/8	0,8

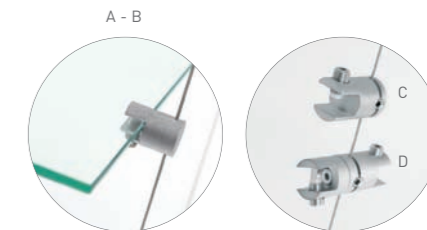

185

E
TEN
cubos

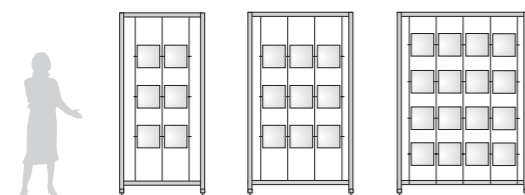

- ES - Cubos
- GB - Boxes
- FR - Boîtes
- DE - Kasten
- IT - Cubi
- PO - Cubos

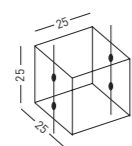

A	kg	?
CUB/25	25 x 25	2 kg



1	2003/TSC	300
---	-----------------	-----

B	2000/9	0,8
C	2000/10	0,8



G
TEN
estante
inclinado

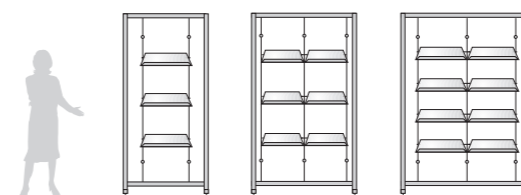

- ES - Estante inclinado
- GB - Inclined shelf
- FR - Tablettes inclinées
- DE - Schiefe regalboden
- IT - Mensola inclinata
- PO - Prateleira inclinada

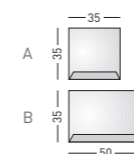

A	ST/EI/1	35 x 35	0,2
B	ST/EI/2	35 x 50	0,2



1	E/EST/TEN	300
---	------------------	-----

C	2000/5	0,4
D	2000/6	0,4

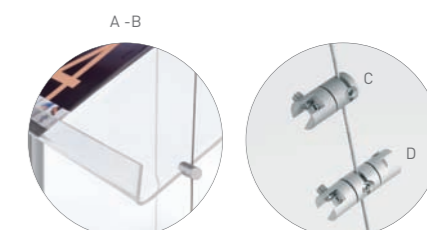



A
frame

A	↕	↔	⏏	?
850/I/M0	87 x 122	82 x 117	1,2	A0
850/I/M1	63 x 87	57 x 82	1,2	A1
850/I/M2	45 x 63	40 x 58	1,2	A2
850/I/M3	73 x 103	68 x 98	1,2	Poster
850/I/M4	53 x 73	48 x 68	1,2	Poster
850/I/M5	32 x 44	29,7 x 42	1,2	A3
850/I/M6	23 x 32	21 x 29,7	1,2	A4

* Marco inglese
* Mitred corner

* pg. 178

B	↕	↔	⏏	?
850/M0	87 x 122	82 x 117	1,2	A0
850/M1	63 x 87	57 x 82	1,2	A1
850/M2	45 x 63	40 x 58	1,2	A2
850/M3	73 x 103	68 x 98	1,2	Poster
850/M4	53 x 73	48 x 68	1,2	Poster
850/M5	32 x 44	29,7 x 42	1,2	A3
850/M6	23 x 32	21 x 29,7	1,2	A4

* Cantonera redonda negra
* Black round corner



NEW

B
displays

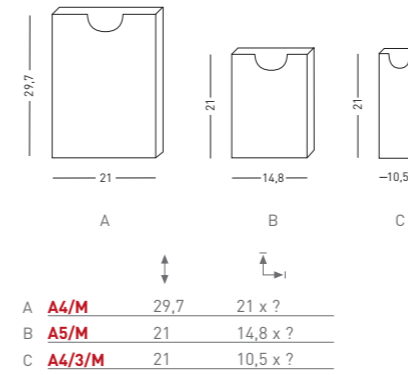

C
displays



D
ledbox

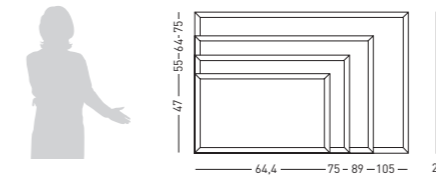

E
shelf

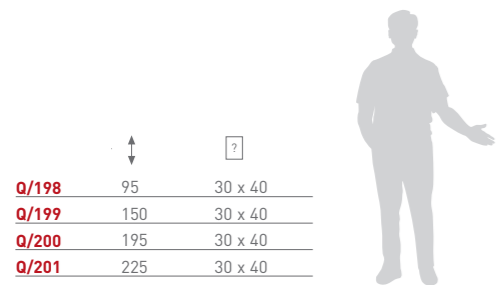

* No incluye portapóster
* Snap Frame not included

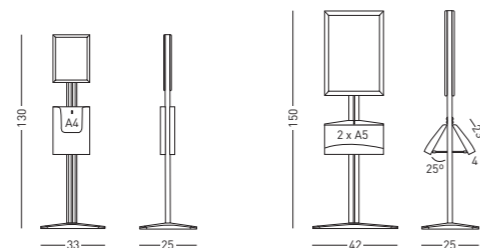

* No incluye portapóster
* Snap Frame not included

ES | Poste de información "Quadra"

Sistema de exposición compuesto de un perfil de aluminio anodizado plata mate vertical, con base metálica cuadrada pintada en color gris. El perfil tiene dos ranuras sobre las que podemos aplicar diferentes accesorios, pinzas, portafolletos, etc...

FR | Barre d'information "Quadra"

Système d'exposition composé d'une barre verticale en aluminium anodisé de couleur argent avec un socle carré en métal de couleur gris. La barre est rainurée sur ses 2 cotés opposés pour y fixer différents accessoires, pinces, portes brochures ou dépliants.

IT | Sistema "Quadra"

Sistema per display composto da un profilo in alluminio anodizzato naturale con base metallica squadrata verniciata in grigio. Il profilo ha 2 slots che possono essere accoppiati con accessori come morsetti, porta documenti, ecc.

GB | Info System "Quadra"

Display system composed of a vertical matt silver aluminium anodised profile with a metallic square base painted in grey. The profile has 2 slots to be fitted with accessories like grips, document holders, etc. Ideal for congresses, exhibitions, sale points, etc..

DE | Info-Ständer "Quadra"

Schilderungssystem mit einem senkrecht mattsilber anodisierten Aluminiumprofil, silber eloxiert, und einen metallischen Quadrat-Fuß in grau gefärbt. Auf das Profil liegen zwei Schlitz für verschiedene Zubehör: Klemmträger, Prospektablagen, etc.

PO | Poste de informação "Quadra"

Sistema de exposição composto por um perfil vertical em alumínio anodizado na cor prata mate, com base metálica quadrada pintada na cor cinzenta. O perfil tem duas ranhuras sobre as quais se podem aplicar diferentes acessórios: pinças, porta folhetos, etc...

F
exemples





	↑	→	↳
A 8801	9,5 x 30 x 14	0,5	
B 8802	35 x 22 x 5	0,5	
C 8803	5 x 27 x 38	0,5	
D 8804	29,5 x 22 x 24	0,5	
E 8805	34,5 x 33 x 18	0,5	
F 8808	9,5 x 3 x 27	0,5	
G 8811	27 x 28 x 35	0,5	
H 885	76 x 38 x 40	0,5	

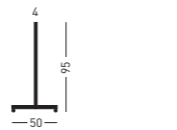
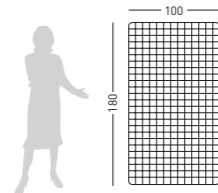

ES | Paneles rejilla

Paneles rejilla metálicos de color negro, contruidos con varilla de hierro de 0,5 cm, formando una malha de 7 cm. Puede colgarse a la pared o montarse con pies forma "T" con ruedas. Sobre el panel podemos situar una extensa gama de accesorios.

GB | Grid panels

Black metallic grid panels which can be hung on walls or on "T" support frame [with castors]. Black metallic stems have a diameter of 0,5 cm, and formed a 7 cm. net. Place a large range of accessories [also made with thin metallic stems].

FR | Panneaux grille

Panneaux grille noir métallique en fer 0,5 cm, formant une cloison de 7 cm. Grande flexibilité de configuration. Fixation murale ou sur piètement "T" avec roulettes. Sur les panneaux on peut fixer très facilement une gamme étendue d'accessoires.

DE | Gitter-stellwandsystem

Stabiles Metallgitter Stellwandsystem mit Eisengittern 0,5 cm für ein ansprechendes Gesamtbild 7 cm. Für eine Wandmontage oder auf "T" Füße mit Rädern. Die aus Metallgitter 0,5 cm hergestellte Produkte sind schnell und bequem aufzuhängen.

IT | Pannello grigliato

Pannello grigliato nero che può essere agganciato al muro o utilizzato autoportante con l'apposita struttura a T. La rete metallica ha un diametro di 0,5 cm, e forma una maglia di 7 cm, utilizzabile con una vasta gamma di accessori (anche in metallo).

PO | Painéis de rede

Painéis metálicos em rede na cor preta, contruidos com vara de ferro de 0,5 cm., formando uma malha com 7 cm. Pode-se pendurar na parede ou montar-se sobre pés em forma de "T" com rodas. Sobre o painel pode-se colocar uma extensa gama de acessórios.

A

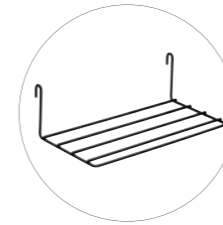

8801

ES - Estante plano
GB - Straight shelf
FR - Étagère plate
DE - Ebener Warenträger
IT - Mensola piana grigliata
PO - Prateleira plana

B

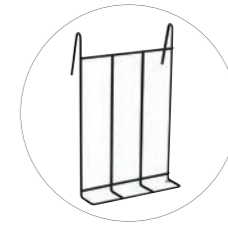

8802

ES - Estante vertical
GB - Vertical shelf
FR - Étagère verticale
DE - Senkrechter Warenträger
IT - Mensola inclinata grigliata per libri
PO - Prateleira vertical para livros

C

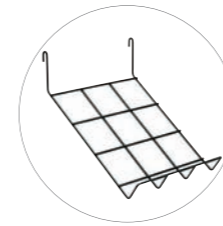

8803

ES - Estante inclinado
GB - Slant shelf
FR - Étagère inclinée
DE - Schräggitter Warenträger
IT - Mensola inclinata grigliata per riviste
PO - Prateleira inclinada para revistas

D

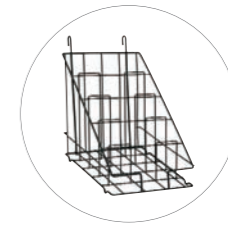

8804

ES - Revistero vertical
GB - Magazine basket
FR - Porte-revues vertical
DE - Zeitschriftenständer
IT - Contenitore verticale grigliato (depliant)
PO - Prateleira para revistas vertical

E

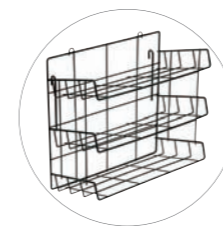

8805

ES - Triple estante plano
GB - Triple straight shelf
FR - Triple Étagère plate
DE - Dreifach ebener Warenträger
IT - Contenitore verticale grigliato (riviste)
PO - Porta revistas plano

F

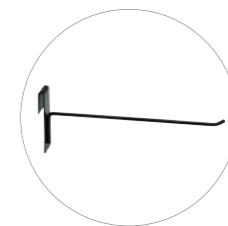

8808

ES - Gancho recto
GB - Wire Hook
FR - Crochet droit
DE - Gitter-Einzelhaken
IT - Ganccio dritto per griglia
PO - Gancho recto

G

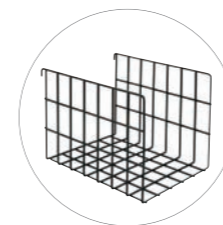

8811

ES - Cesto multifunción
GB - Multifunction basket
FR - Corbeille multifonctions
DE - Mehrzweck-Korb
IT - Contenitore multifunzione per griglia
PO - Cesto multifuncional

H



885

ES - Carro portaplanos
GB - Map trolley
FR - Chariot pour plans
DE - Karte Laufkatze
IT - Cesto grigliato
PO - Carro para planos

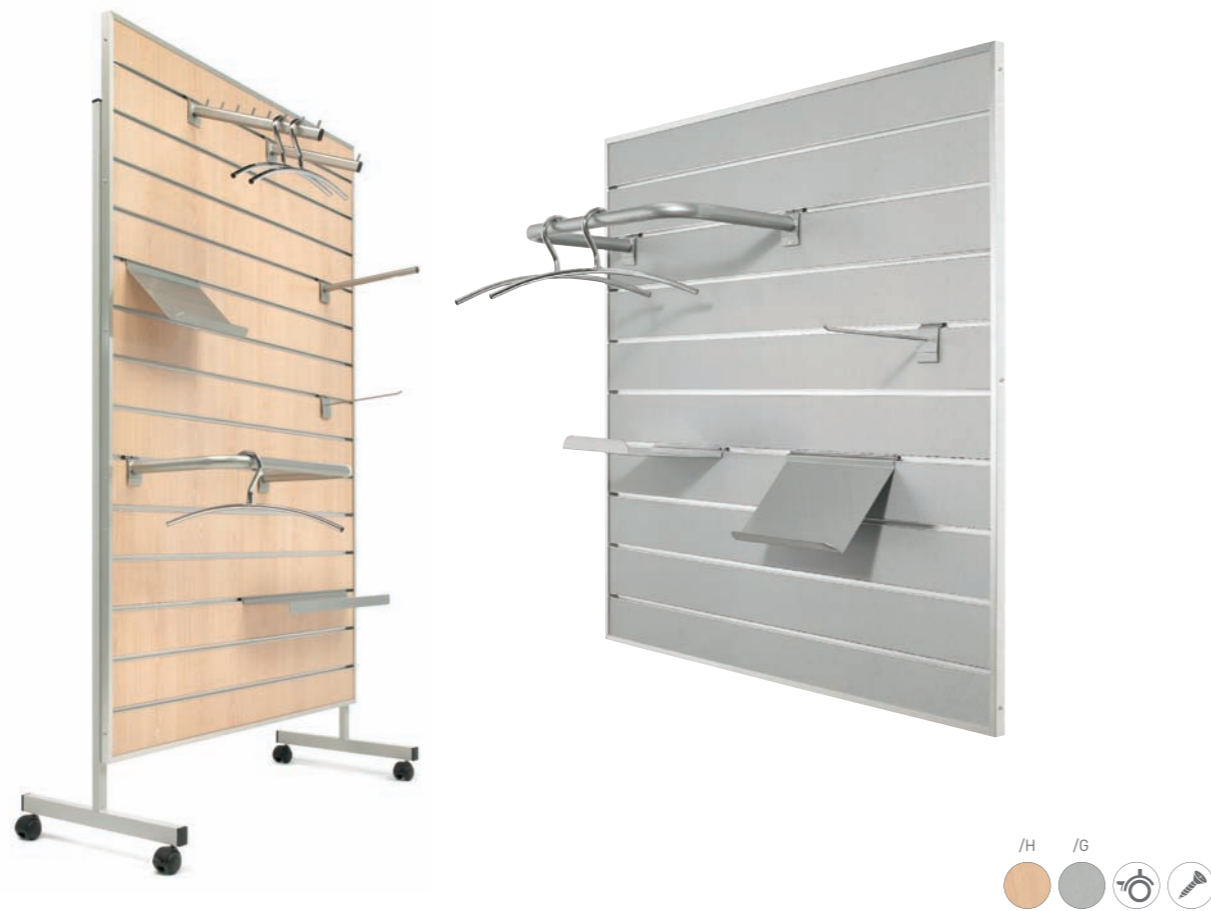

	1	2	3	4	5	6
1	890/T1	180 x 120	2,5	14		
2	890/T2	120 x 120	2,5	9		
3	890/T3	120 x 60	2,5	9		
4	890/1	180 x 120	2,5	14		
5	890/2	120 x 120	2,5	9		
6	890/3	120 x 60	2,5	9		

ES | Panel ranurado

Panel de madera ranurado, para el equipamiento de instalaciones comerciales, para sujeción de elementos de exposición, tales como ganchos, barras, soportes, estantes, etc... Disponibles en varias medidas y colores haya y gris. Versión mural o ruedas.

GB | Slotted wood panel

Slotted wood panel for the equipment of stores, facilities, seizure of exhibition parts such as hooks, bars, supports, shelves, etc. Available in several measurements and beech and grey colours, as well as wall or mobile support on castors.

FR | Panneau bois rainuré

Panneau en bois et en aluminium, rainuré pour les magasins/commerces/bureaux. Les rails en aluminium permettent d'adapter des accessoires pour la présentation/exposition/rangement grâce ansa accessoires comme le crochet, tablette, barre...

DE | Geschlitzene holztafel

Geschlitzene Holztafel für die Ausstattung von Läden, und Befestigung von Ausstellungselemente wie Haken, Stangen, Regale usw... Verfügbar in mehreren Größen und Farben (Buchenholz und grau), genauso wie Wand-oder Mobil mit Rollen.

IT | Pannello in doghe di legno

Pannello in doghe di legno per arredamento di negozi, magazzini, scaffali, parti di fiere con una vasta gamma di accessori. Disponibile in diverse misure ed in finitura faggio e grigio e con fissaggio diretto a muro o su struttura autoportante con ruote.

PO | Painel ranhurado

Painel ranhurado em madeira, para instalações comerciais, podendo-se pendurar elementos de exposição, tais como ganchos, barras, suportes, prateleiras, etc... Disponíveis em várias medidas e nas cores faia e cinzento, na versão de parede ou com rodas.

A

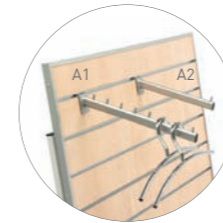

- A1 **8901**
ES - Portaperchas
GB - Hanging Bracket
FR - Porte cintres
DE - Aufhänger
IT - Braccio per appenderia
PO - Porta cabides
- A2 **8902**
ES - Brazo inclinado
GB - Downslant bracket
FR - Bras incliné
DE - Schräger Träger
IT - Braccio inclinato
PO - Braço inclinado para cabides

B

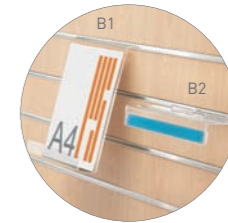

- B1 **8903**
ES - Portafolletos A4
GB - Document holder A4
FR - Porte-brochures A4
DE - Prospekthalter A4
IT - Porta documenti A4
PO - Porta folhetos A4
- B2 **8904**
ES - Estante plano PVC
GB - Straight shelf PVC
FR - Étagère plate PVC
DE - Ebener Warenträger PVC
IT - Mensola diritta in PVC
PO - Prateleira Plana PVC

C



- 8905**
ES - Estante de madera
GB - Wood shelf
FR - Étagère en bois
DE - Holz-Warenträger
IT - Mensola in legno
PO - Prateleira de madeira

D



- 8906**
ES - Barra colgar "U"
GB - Hanging Bar "U"
FR - barre en "U"
DE - Aufhängestange "U"
IT - Barra per appenderia ad "U"
PO - Barra em forma de "U"

E

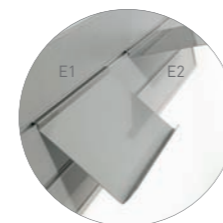

- E1 **8907**
ES - Estante inclinado chapa
GB - Slant shelf (sheet metal)
FR - Étagère inclinée en tôle
DE - Schräger Warenträger (Blech)
IT - Mensola inclinata in metallo
PO - Prateleira inclinada em chapa
- E2 **8908**
ES - Estante recto chapa
GB - Straight shelf (sheet metal)
FR - Étagère droite en tôle
DE - Schräger Warenträger (Blech)
IT - Mensola diritta in metallo
PO - Prateleira plana em chapa

F

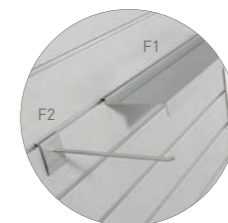

- F1 **8909**
ES - Estante recto largo
GB - Long straight (sheet metal)
FR - Étagère droite longue
DE - Lang, gerader Warenträger
IT - Mensola lunga in metallo
PO - Prateleira plana grande
- F2 **8910**
ES - Gancho recto
GB - Wire Hook
FR - Crochet droit
DE - Gerader Einzelhaken
IT - Gancio diritto
PO - Gancho recto

G

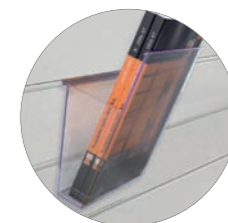

- ES - Expositor "Vision"
- GB - Holder "Vision"
- FR - Porte brochures "Vision"
- DE - Prospektständer "Vision"
- IT - Porta documenti "Vision"
- PO - Porta documentos "Vision"

VIS/A4 - VIS/1/3/A4

A1	8901	40 x 3 x 1,5
A2	8902	32 x 3 x 1,5
B1	8903	22 x 33 x 6
B2	8904	25 x 10 x 6
C	8905	60 x 35 x 2
D	8906	60 x 30 x 7,5
E1	8907	20 x 30 x 3
E2	8908	26 x 24 x 3
F1	8909	58 x 14 x 3
F2	8910	25 x 5 x 7,5
G	VIS/A4	25 x 23 x 4,5
G	VIS/1/3/A4	16 x 11 x 4

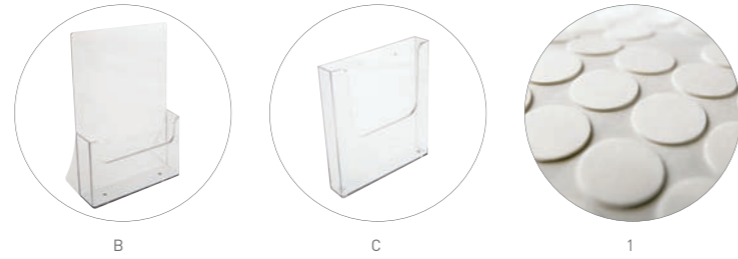

A
A5

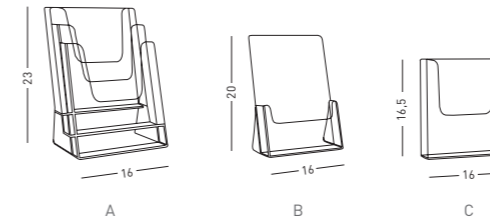

	↙	↘	↙	↘	uts.
A	A5/V3	23 x 16 x 3,5	3,5	A5/V3/5	12
B	A5/S	20 x 16 x 3,5	3,5	A5/S/10	40
C	A5/M	16,5 x 16 x 3,5	3,5	A5/M/10	45

* BOX



B
1/3 A4

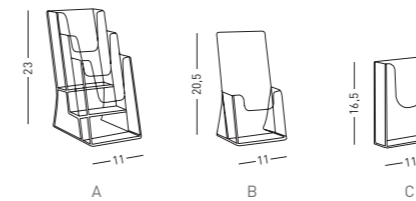

	↙	↘	↙	↘	uts.
A	A4/3/V3	23 x 11 x 3,5	3,5	A4/3/V3/5	20
B	A4/3/S	20,5 x 11 x 3,5	3,5	A4/3/S/10	50
C	A4/3/M	16,5 x 11 x 3,5	3,5	A4/3/M/10	60

* BOX

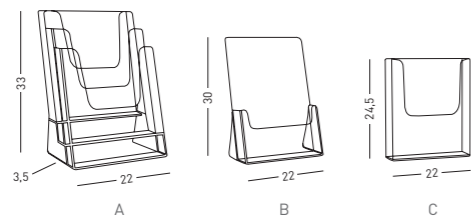

	↙	↘	↙	↘	uts.
A	A4/V3	33 x 22 x 3,5	3,5	A4/V3/5	4
B	A4/S	30 x 22 x 3,5	3,5	A4/S/10	20
C	A4/M	24,5 x 22 x 3,5	3,5	A4/M/10	30

* BOX

1 **H/50** 10 x 20 50

ES | Portafolletos de metacrilato

Expositores para folletos DIN A4 fabricados en metacrilato transparente de alta resistencia. La diversidad de acabados: mural, sobremesa simple y sobremesa triple, permiten obtener un perfecto soporte para cada necesidad.

FR | Porte-brochures méthacrylate

Porte-Brochures A4 fabriqués en méthacrylate transparent de haute résistance. Gamme très étendue de finitions: usage mural, usage comptoir simple et triple pour tous les besoins.

IT | Espositore da tavolo

Espositore da tavolo formato A4 in metacrilato ad alta resistenza. Disponibile nelle versioni singolo e triple. E' possibile mettere il porta depliant su muri, lavagne e pannelli con adesivo se necessario.

GB | Document holders

High resistant transparent methacrylate document holders. Format A4. Many different finishings: wall, table and triple table that allow you to display all types of documents such as catalogues, brochures, cards for every need, etc.

DE | Prospektaufsteller

Material: Aus hochwertigem Acrylglas. Für Prospektangebote aller Art. In verschiedenen Ausführungen (Wand-, Tischaufsteller und dafür einsetzbar in Büros, öffentlichen Einrichtungen, Wartezimmern, Einzelhandelsgeschäften, Messen.

PO | Porta folhetos

Expositores para folhetos DIN A4 fabricados em acrílico transparente de alta resistência. A diversidade de acabamentos: de parede, de mesa simples e de mesa triplo, permite obter um suporte perfeito para cada necessidade.

C
colours



* Bajo pedido
* Under order



A

B - C

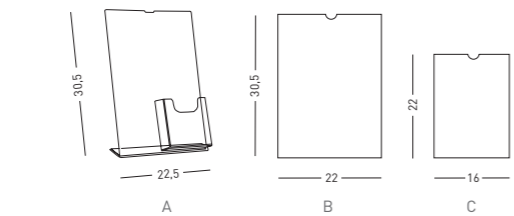

	A	B	C	uts.	
A	PF/A4/3	30 x 21 x 0,5	0,5	PF/A4/3/10	10
B	PF/A4/M	30,5 x 22 x 0,5	0,5	PF/A4/M/10	10
C	PF/A5/M	22 x 16 x 0,5	0,5	PF/A5/M/10	10

* BOX

ES | Displays Acrylic

Displays portafolletos fabricados en acrílico transparente de alta resistencia. La diversidad de acabados; mural, sobremesa y sobremesa con triptico, permiten obtener un perfecto soporte para cada necesidad.

FR | Porte-visuels Acrylic

Porte Visuels fabriqués en acrylic transparent de haute résistance. Gamme très étendue de finitions: usage mural, usage comptoir simple et triple pour tous les besoins.

IT | Porta foto

Porta documenti/foto in acrylic trasparente. Diverse finiture; da tavolo e da muro. Per il muro utilizzare gli appositi biadesivi.

GB | Acrylic displays

High resistant transparent acrylic document holders. Many different finishings: wall, table and triple table that allow you to display all types of documents such as catalogues, brochures, cards for every need.

DE | Prospektaufsteller

Material: Aus hochwertigem Acrylglas. Für Prospektangebote aller Art. In verschiedenen Ausführungen (Wand-, Tischaufsteller und dafür einsetzbar in Büros, öffentlichen Einrichtungen, Wartezimmern, Messen, etc...).

PO | Porta cartazes em acrílico

Porta cartazes fabricados em acrílico transparente de alta resistência. A diversidade de acabamentos: de parede, de mesa e de mesa com triptico, permitem obter um suporte perfeito para cada necessidade.

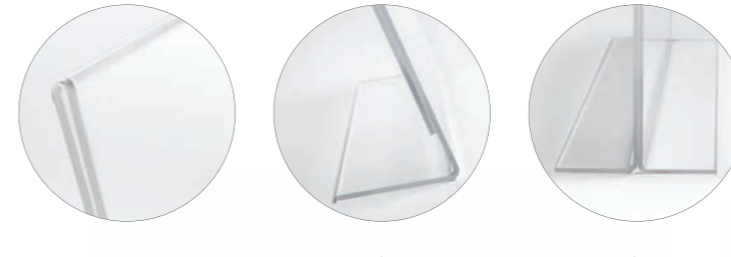

L

T



	L	T	?	?
BL/EX/0012	21 x 29,7	A4	V	
BL/EX/0013	29,7 x 21	A4	H	
BL/EX/0014	14,8 x 21	A5	V	
BL/EX/0015	21 x 14,8	A5	H	
BL/EX/0016	10,5 x 14,8	A6	V	
BL/EX/0017	14,8 x 10,5	A6	H	
BL/EX/0018	10,5 x 21	1/3 A4	V	
BL/EX/0019	21 x 10,5	1/3 A4	H	

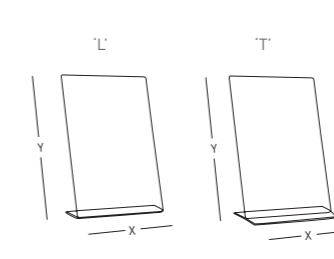

	T	?	?
BL/EX/0032	21 x 29,7	A4	V
BL/EX/0033	29,7 x 21	A4	H
BL/EX/0034	14,8 x 21	A5	V
BL/EX/0035	21 x 14,8	A5	H
BL/EX/0036	10,5 x 14,8	A6	V
BL/EX/0037	14,8 x 10,5	A6	H
BL/EX/0038	10,5 x 21	1/3 A4	V
BL/EX/0039	21 x 10,5	1/3 A4	H

ES | Display Acrylics

Gama de portadocumentos fabricados en acrílico transparente de alta resistencia. Disponibles en formato "T" y "L" y cada uno de ellos en tamaño A4, A5, A6 y 1/3 de A4 tanto en formato vertical como en horizontal.

FR | Display Acrylics

Gamme de supports et porte-documents en acrylique transparent de haute résistance. Disponible en "T" et "L" et disponibles en formats A4, A5, A6 et 1/3 de format A4 à la fois verticalement et horizontalement.

IT | Display Acrilici

Gamma di portadocumenti realizzato in acrílico trasparente ad alta resistenza. Disponibile in formato "T" e "L" e ognuno di essi misura A4, A5, A6 e 1/3 di A4 sia verticale che orizzontale.

GB | Display Acrylics

Range document holder made of high strength transparent acrylic. Available as "T" and "L" and each of them in A4, A5, A6 and 1/3 of A4 format both vertically and horizontally.

DE | Sortiment von Dokumentenhaltern

Sortiment von Dokumentenhaltern aus hochwertigem, transparentem Acrylglas. Erhältlich im Format "T" und "L", horizontal wie auch vertikal in den Größen A4, A5, A6 und 1/3 von A4.

PO | Display Acrílico

Gama de porta documentos fabricados em acrílico transparente de alta resistência. Disponíveis em formato "T" e "L", e cada um deles em formato A4, A5, A6 e 1/3 de A4 tanto em posição vertical como em horizontal.



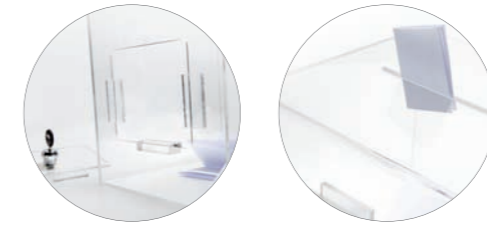
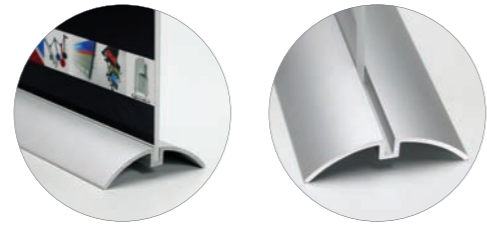

196

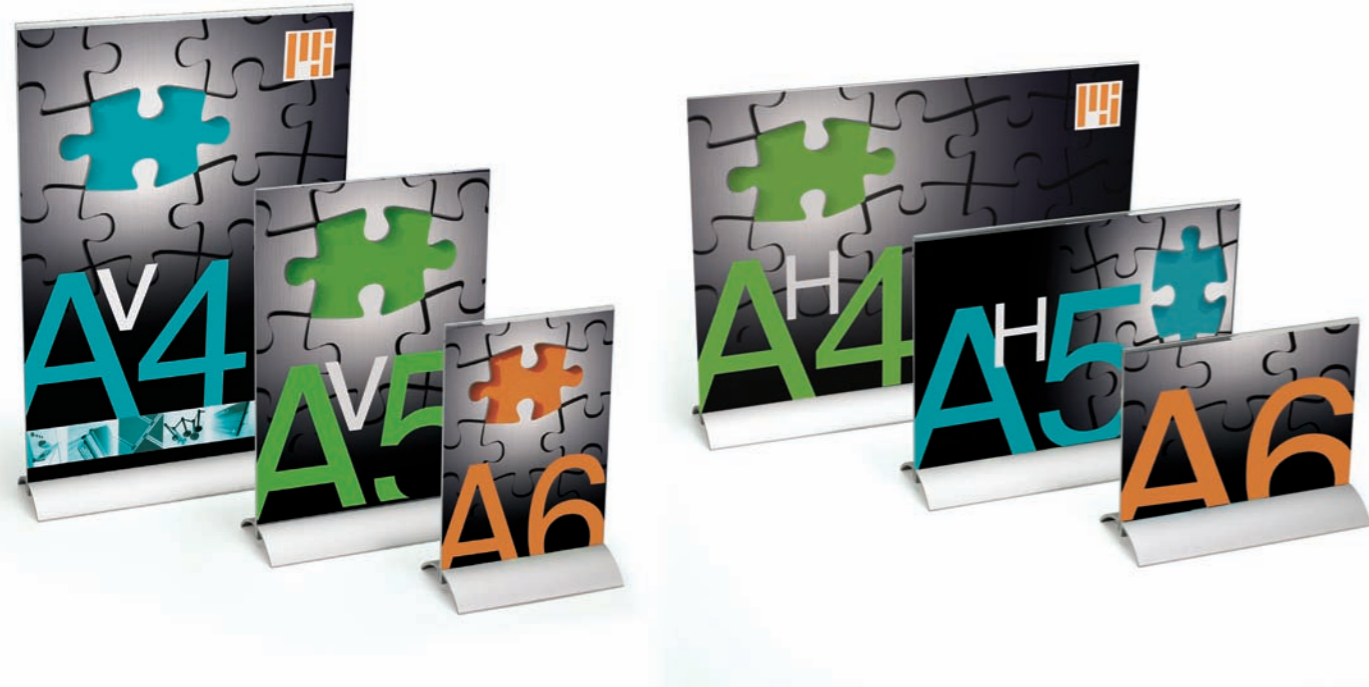

197



NEW

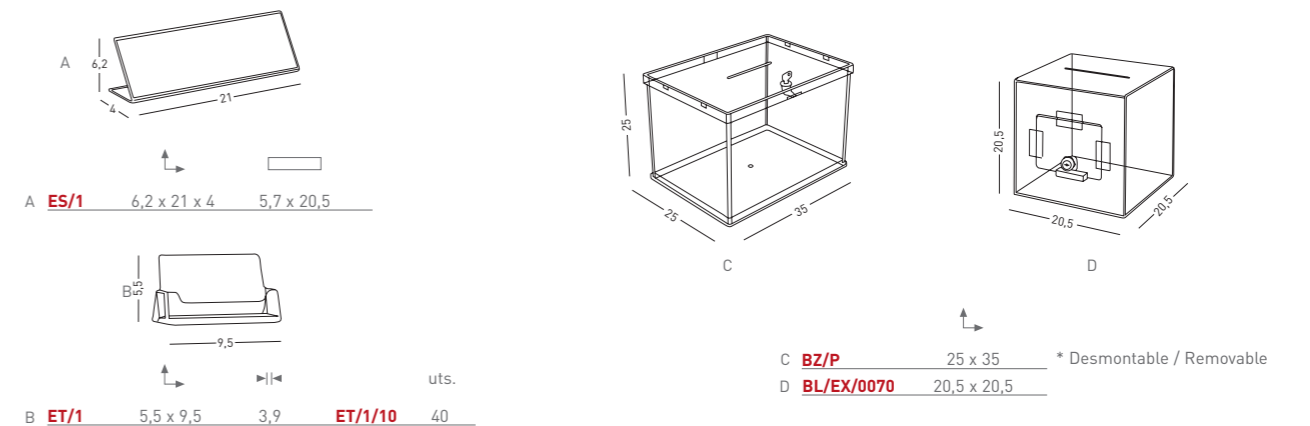
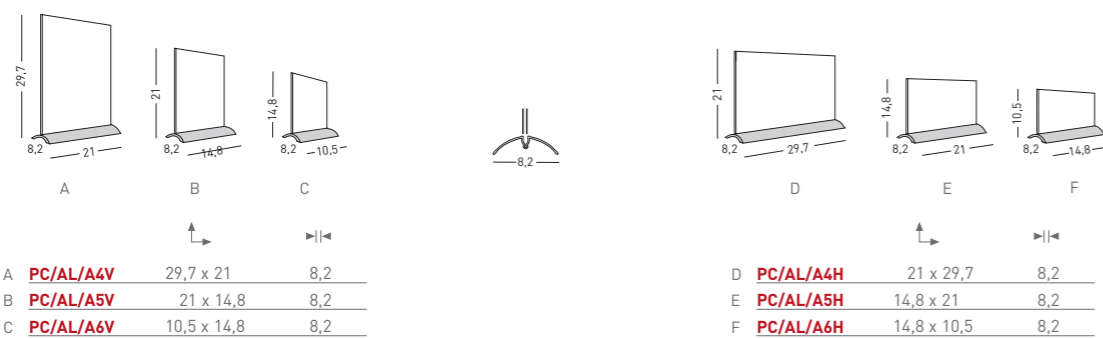

ES | Portacarteles con base de aluminio
Expositor portacarteles fabricado en metacrilato transparente de alta resistencia y base de aluminio anodizada en plata mate. La diversidad de formatos; A3, A4, A5, en formato vertical u horizontal, permiten obtener un perfecto soporte para cada documento.

FR | Porte-visuel et aluminium
Porte visuel A4, A5 et A6 fabriqué en méthacrylate transparent de haute résistance avec socle aluminium. Usage vertical ou horizontal. Idéal pour des menus, listes de prix, soldes, etc...

IT | Porta avvisi da tavolo
Resistente porta documenti in acrilico trasparente con base in alluminio anodizzato Silver. Formati A3, A4, A5 sia verticale che orizzontale. E' possibile mettere il porta depliant su muri, lavagne e pannelli con adesivo se necessario. Ideale per menù di ristoranti, listini, ecc.

ES | Portarrótuolos, tarjetero y buzón
Porta tarjetas y portarrótuolos de metacrilato de alta resistencia. El portarrótuolos puede situarse en 2 posiciones. Buzón de sugerencias desmontable fabricado en metacrilato transparente de alta resistencia.

FR | Support information et cartes de visite
Fabriqué en méthacrylate très résistant. Le support d'information peut se positionner de deux façons. Boîte à suggestions démontable en méthacrylate transparent très résistant.

IT | Porta scontrini e carte
Il porta carte e porta scontrini è in metacrilato ad alta resistenza. Il porta scontrini ha 2 posizioni. Caselle di suggerimento smontabili costruite in acrilico trasparente ad alta resistenza.

GB | Aluminium document holder
High-resistant transparent acryl document holders and silver anodised aluminium base. Format A3, A4, and A5, either vertical or horizontal. Ideal for the display of menus at the restaurants, price lists, etc...

DE | Acryl-Präsentationsständer
Material: Aus hochwertigem Acrylglas und Alu-Standfuß; silber eloxiert. Format: A4, A5 und A6. Wahlweise als Hoch- und Querformat verwendbar. Mit entsprechenden Informationen und Werbetexten kann der Kartenhalter vielseitig eingesetzt werden.

PO | Porta cartazes em acrílico e alumínio
Expositor porta cartazes fabricado em acrilico transparente de alta resistência e base em alumínio anodizado na cor prata mate. A diversidade de formatos, A3, A4, A5, na vertical e horizontal, permitem obter um suporte perfeito para cada documento.

GB | Information and business card holder
Made of high resistant methacrylate. The name holder can be placed in two different way. Suggestion box made of resistant transparent methacrylate.

DE | Namenschilder und Visitenkartenhalter
Namenschilder und Visitenkartenhalter aus hochwertigem Metachrylat hergestellt. Die Namenschildern sind in 2 Position zu stellen. Briefkasten für Anregungen aus hochwertigem Acrylglas hergestellt.

PO | Porta nomes e porta cartões
Porta cartões de visita e porta nomes em acrílico de alta resistência. O porta nomes pode ser colocado em 2 posições diferentes. Urna de sugestões desmontável, em acrilico transparente de alta resistência.

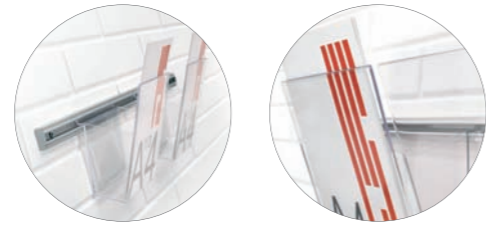

198

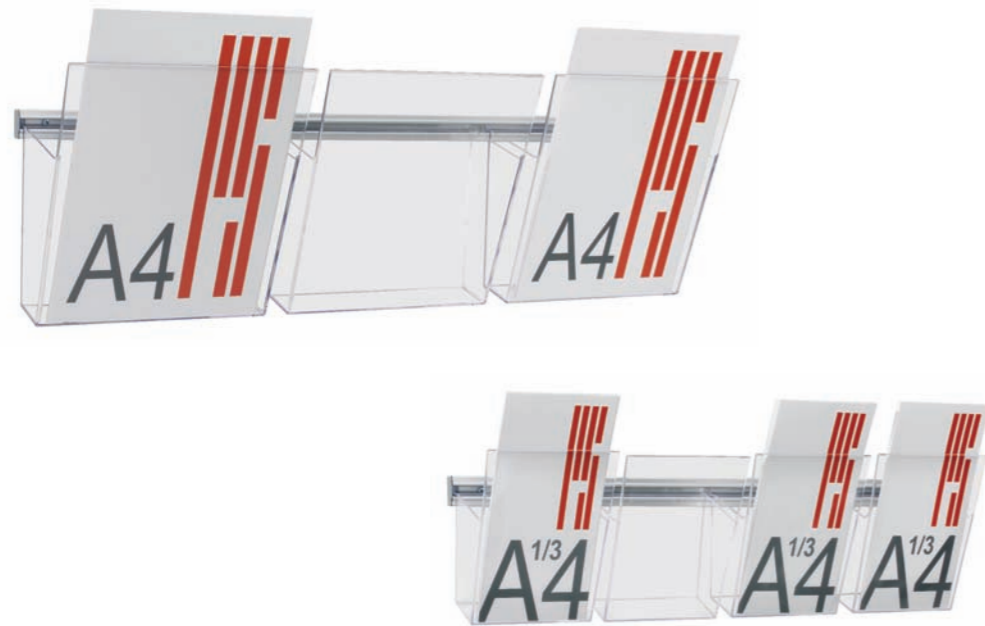

	A	B	C		D	E	F		
	↕ ↔ □ ?				↕ ↔ □ ?				
A	VS/3	25 x 75 x 14	25 x 25 x 14	A4	D	M/VS/6	16 x 75 x 11	16 x 25 x 11	1/3 A4
B	VS/2	25 x 50 x 14	25 x 25 x 14	A4	E	M/VS/4	16 x 50 x 11	16 x 25 x 11	1/3 A4
C	VS/1	25 x 25 x 14	25 x 25 x 14	A4	F	M/VS/2	16 x 25 x 11	16 x 25 x 11	1/3 A4

ES | Expositores murales "Vision"

Portafolletos de metacrilato transparente Vision, A4 y 1/3 de A4 que se fijan a la pared mediante un carril de aluminio en forma de "u". Disponibles en formato A4 de 1, 2 y 3 casillas, y en formato tríptico de 2, 4 y 6 casillas.

FR | Présentoir mural "Vision"

Porte brochures en méthacrylate transparent Vision, format A4, 1/3 A4 se fixant au mur à l'aide d'un rail en aluminium en forme de "U". Disponible en format A4 avec 1, 2 ou 3 pochettes et en format "dépliants" avec 2, 4 ou 6 pochettes.

IT | Espositore da muro "Vision"

Resistente porta documenti VISION, A4 ed 1/3 A4 in metacrilato trasparente. Le tasche possono essere fissate al muro usando un binario in alluminio con forma ad "u". Disponibile in A4 con 1, 2, 3 tasche e 4, 6 in formato 1/3 A4.

GB | Wall brochure holder "Vision"

High resistant transparent methacrylate document holders Vision, A4 and 1/3 A4. They can be fixed to the wall using an aluminium rail with shape of "u". Available in A4 with 1, 2 and 3 trays and 4 and 6 trays in 1/3 A4 format.

DE | Wand-Prospekthalter "Vision"

Acryl-Prospekthalter, durchschaubar Vision, DIN A4 und 1/3 A4, die mit einer Alu-Schiene "U"- förmig an die Wand befestigt werden können. Format A4, 1, 2, und 3 Fächer, und Format dreiteiliges Dokument 2, 4 und 6 Fächer verfügbar...

PO | Porta documentos de parede "Vision"

Porta folhetos em acrílico transparente VISION, A4 e 1/3 de A4 que se fixam à parede mediante um carril de alumínio em forma de "U". Disponíveis no formato A4 de 1, 2 e 3 compartimentos e no formato tríptico de 2, 4 e 6 compartimentos.

199



* Transport bag included



NEW

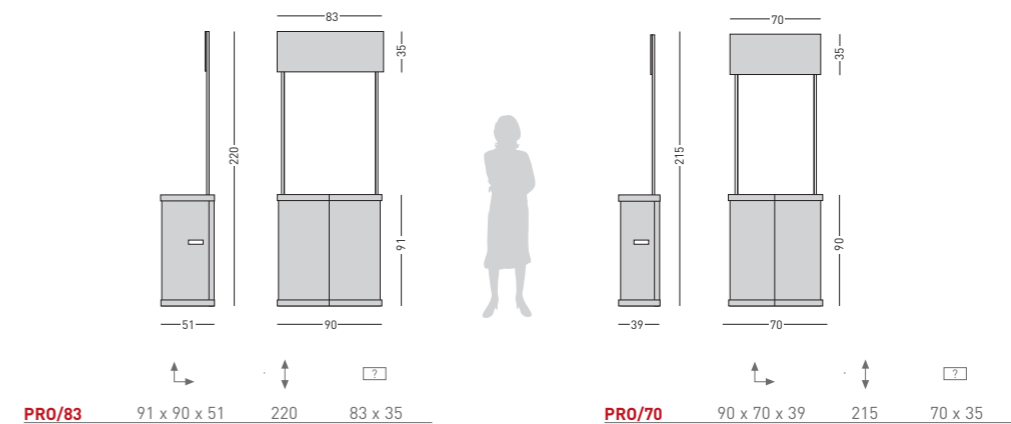

ES | Promostand

Stands de demostración de producto de plástico desmontables y personalizables con impresión según necesidad. Disponibles en 2 tamaños y provistos de banderola también personalizables. Incluyen bolsa de transporte.

FR | Promostand

Stands de démonstration de produits en plastique avec impression amovible et personnalisable selon les besoins. Disponible en 2 formats, fourni une bannière personnalisable. Livré un sac de transport.

IT | Promostand

Stands dimostrativo in materiale plastico smontabile e personalizzabile con immagini secondo necessità. Disponibile in 2 dimensioni e provvisto di bandiera personalizzabile. Inclusa la borsa per il trasporto.

GB | Promostand

Plastic stand corner. Foldable and customisable with your name, message or logo on a print to make your own. Two formats and including a flat which is also to customize. It include a transport bag.

DE | Produktausstellungsstand

Produktausstellungsstand aus Plastik, demontierbar und nach Ihren Wünschen bedruckbar. Erhältlich in zwei Größen, das Banner kann ebenfalls bedruckt werden. Zubehör: Transportbeutel.

PO | Stand em plástico desmontável

Stands de demonstração de produto em plástico, desmontáveis e personalizáveis com impressão de acordo com cada necessidade. Disponíveis em 2 tamanhos e com bandeira personalizável. Incluí mala de transporte.

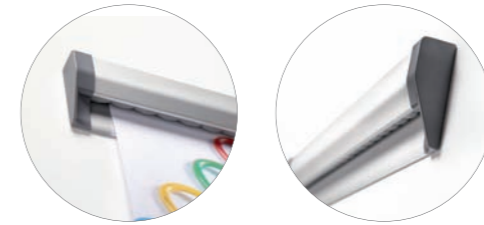
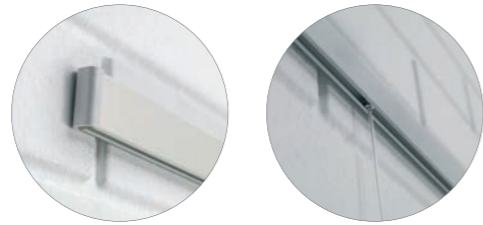

200



	3	200	1
	A		
A	CC/150	3 x 200	1
	Cable		1
	CC/1		0,1

ES | Rail para colgar cuadros

Rail de aluminio mural color plata mate, para colgar cuadros. Permite cambiarlos sin tener que atornillarlos en la pared. Ideales para salas, galerías de arte, recepciones, etc. El kit de 200 cm. incluye un juego de 2 cables.

FR | Rail pour accrocher des tableaux

Rail mural en aluminium pour suspendre et exposer des tableaux. Couleur argent mat. Ce système permet de changer facilement la composition de tableaux. Idéal pour des salles, des galeries d'art, des réceptions, etc.

IT | Binario in alluminio per immagini

Binario in alluminio per agganciare immagini al muro. Verniciato in silver. Permette di cambiare immagini senza forare i muri. Ideale per stanze, gallerie d'arte, recepciones, etc. Il kit da 200 cm. include 1 set di cavi con accessori in ferro.

GB | Rail for picture hanging

Aluminium rail system for hanging up pictures on the wall. Matt silver colour. It enables different layout without drilling holes on the wall or using screws. Ideal for rooms,.... The fixation kit includes two iron hooks and a set of two 200 cm cables.

DE | Aufhängeschiene

Aluminium silber eloxiert Wandschiene-System, um Bilder an die Wand aufzuhängen. Ohne irgendeine Schraube an der Wand können die Bilder ausgetauscht werden. Ideale für Räume, Kunstgalerien. Der 200-cm. Kit beinhaltet 1 Kabelsätze und Eisenbeschläge.

PO | Perfil para pendurar quadros

Perfil de alumínio de parede na cor prata mate, para pendurar quadros. Permite trocar os quadros sem necessidade de aparafusar à parede. Ideal para salas, galerias de arte, etc. O conjunto de 200 cm. inclui um conjunto de cabos com as suas ferragens.

201

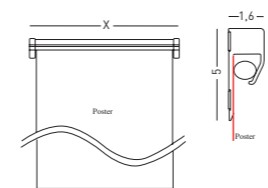

	←→	Poster	→ ←
BL/EX/0040	33,5	31	5
BL/EX/0041	52,5	50	5
BL/EX/0042	60,5	58	5
BL/EX/0043	90,5	88	5
BL/EX/0044	102,5	100	5
BL/EX/0045	120,5	118	5
BL/EX/0046	152,5	150	5

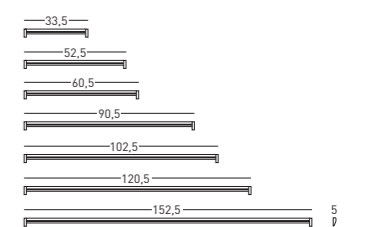

ES | Perfil portanotas

Perfil de aluminio anodizado en color plata mate que se fija a la pared mediante tornillos ocultos en la tapa lateral, para fijar notas, pósters, dibujos, planos, etc. Su parte inferior está rellena de bolas de cristal las cuales fijan el documento de papel de manera segura.

FR | Profil de support de notes

Profil en aluminium anodisé mat, fixé au mur par des vis ou par une bande magnétique (au choix). Idéal pour fixer des notes, posters, dessins, plans, etc... L'intérieur est rempli de billes qui fixent le document. Disponible en 3 longueurs 50, 100 et 200 cm.

IT | Profilo porta avvisi

Profilo in alluminio anodizzato silver fissato a muro tramite viti nascoste dal profilo laterale. Ideale per inserire posters, disegni, planning, ecc. La parte inferiore è piena di biglie che agganciano i documenti di carta in modo sicuro.

GB | Notes holder profile

Silver anodised aluminium profile fixed to the wall through hidden screws on the lateral cover. Ideal for hanging up notes, posters, drawings, plans, etc... The lower part is full of marbles which safely block paper notes.

DE | Profil für dokumente

Profil in anodisiertem Aluminiumrahmen, silber eloxiert das durch versteckte Schrauben in einer seitlichen Abdeckung an der Wand befestigt wird. Ideal für Notizen, Posters, Zeichnungen, Pläne usw... Vorhanden in 3 Größen: 50, 100 und 200 cms.

PO | Perfil de alumínio para fixar mensagens

Perfil de alumínio anodizado na cor prata mate que se fixa na parede através de parafusos ocultos na tampa lateral. Para fixar mensagens, posters, desenhos, planos, etc... A sua parte inferior é composta por várias bolas de vidro, as quais fixam os documentos.



202



NEW

203



NEW

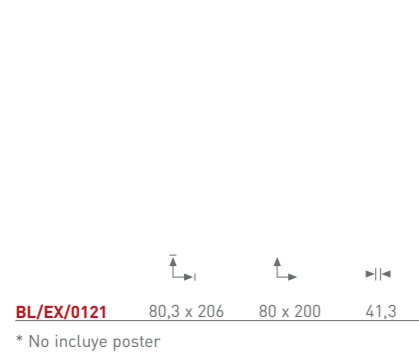

* No incluye poster

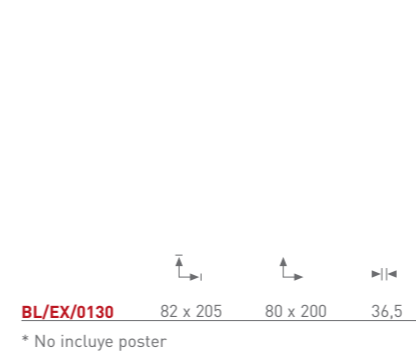
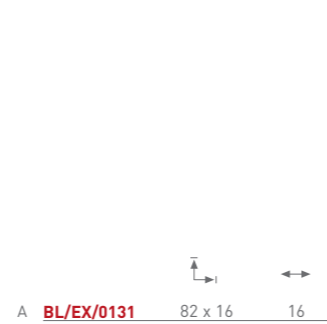
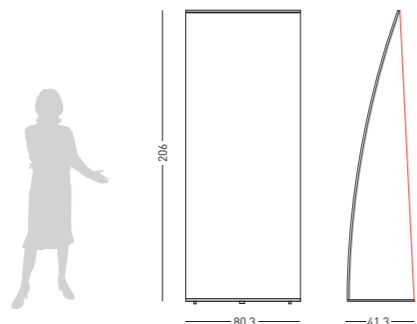

* No incluye poster

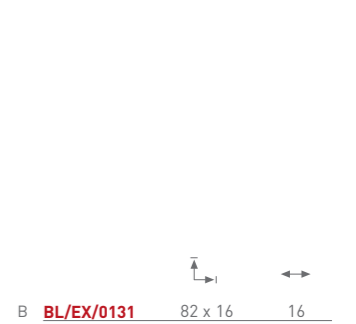
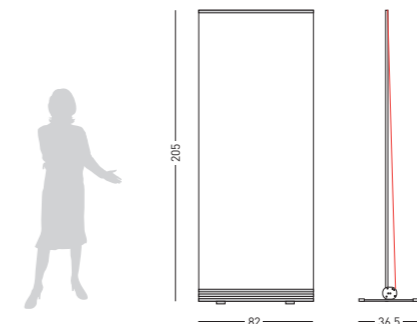

ES | Banner
Gama de Banners y Roll up fabricados en aluminio. Disponen de bolsa de transporte opcional. Ideales para ferias, convenciones, demostraciones de producto...

FR | Banner
Gamme de Roll up et porte Baners en aluminium. Avec en en option un sac de transport. Idéal pour les salons professionnels, congrès, promotion de produits.

IT | Banner
Gamma di Banner e RollUp realizzati in alluminio. Disponibili con borsa di trasporto opzionale. Ideali per fiere, conferenze, dimostrazioni di prodotto, etc.

ES | Roll Up
Gama de Banners y Roll up fabricados en aluminio. Disponen de bolsa de transporte opcional. Ideales para ferias, convenciones, demostraciones de producto...

FR | Roll Up
Gamme de Roll up et porte Baners en aluminium. Avec en en option un sac de transport. Idéal pour les salons professionnels, congrès, promotion de produits.

IT | Roll Up
Gamma di Banner e RollUp realizzati in alluminio. Disponibili con borsa di trasporto opzionale. Ideali per fiere, conferenze, dimostrazioni di prodotto, etc.

GB | Banner
Range and Roll up Banners made of aluminium. They have optional carrying bag. Ideal for trade shows, conventions, product demonstrations...

DE | Banner
Sortiment von Banner und Roll up, hergestellt aus Aluminium. Optional bieten wir einen Transportbeutel an. Ideal für Messen, Kongresse und Produktdemonstrationen.

PO | Banner
Gama de Banners e Roll Up fabricados em alumínio. Disponível mala bolsa de transporte opcional. Ideais para feiras, convenções, demonstrações de produto...

GB | Roll Up
Range and Roll up Banners made of aluminium. They have optional carrying bag. Ideal for trade shows, conventions, product demonstrations...

DE | Roll Up
Sortiment von Banner und Roll up, hergestellt aus Aluminium. Optional bieten wir einen Transportbeutel an. Ideal für Messen, Kongresse und Produktdemonstrationen.

PO | Roll Up
Gama de Banners e Roll Up fabricados em alumínio. Disponível mala bolsa de transporte opcional. Ideais para feiras, convenções, demonstrações de produto...

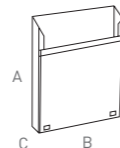
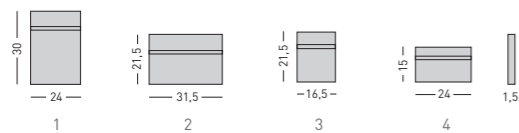
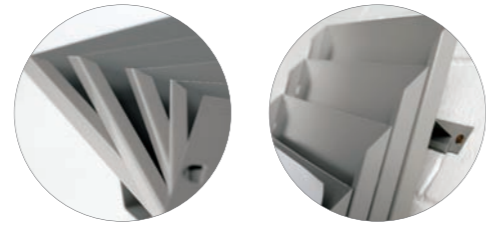

	Ref.	Ref.	Ref.		A	B	C		
1	DIN A4V	A4V/01	A4V/02	A4V/03	1	DIN A4V	30	24	1,5
2	DIN A4H	A4H/01	A4H/02	A4H/03	2	DIN A4H	21,5	31,5	1,5
3	DIN A5V	A5V/01	A5V/02	A5V/03	3	DIN A5V	21,5	16,5	1,5
4	DIN A5H	A5H/01	A5H/02	A5H/03	4	DIN A5H	15	24	1,5

ES | Cajetines metálicos apilables

Cajetines apilables metálicos compuestos de 3 piezas que permiten instalarse en bloques (formato vertical u horizontal). Disponibles en Din A4 y Din A5, son el soporte adecuado para situar documentos. Ref. /01 Soporte pared, /02 Intermedio, /03 Tapa final.

FR | Casiers métalliques

Corbeille en métal superposable et juxtaposable. Très facile à monter. Compartiments modulables qui s'accrochent l'un à l'autre. Dimensions de la corbeille: DIN A4 et DIN A5. Réf.: /01 Support au mur, /02 Intermédiaire, /03 Pièce finale.

IT | Vaschetta metallica

Vaschetta metallica composta da 3 parti indipendenti che possono essere unite in blocco in verticale o in orizzontale. Disponibile in Din A4 e DA5. Adatto per tutti i tipi di documenti. Vaschetta Ref. /01 con supporto a muro, /02 Intermedio, /03 Finale.

GB | Attachable metallic trays

Attachable metallic trays composed by 3 independent pieces that can be joined as blocks horizontally and vertically. Available in Din A4 and Din A5. Suitable for all kinds of documents: mail, cards, files, pamphlets, etc. Ref. /01 wall support, /02 Middle Tray, /03 Ending.

DE | Metallablagebox

Ablagebox mit weiten Taschen, die vertikal oder horizontal hintereinander gesteckt werden können (je nach Modell). Erhältlich in den Formaten DIN A4 und DIN A5. Es ermöglicht Ihnen, ihre Dokumente, Post, Kataloge und Belege zu ordnen und zu sortieren.

PO | Caixas metálicas empilháveis

Caixas metálicas empilháveis, compostas por 3 peças que permitem ser instaladas em blocos (formato vertical ou horizontal). Disponíveis em DIN A4 e DIN A5. Refª /01 Suporte de parede, /02 Intermédio, /03 Tampa final.

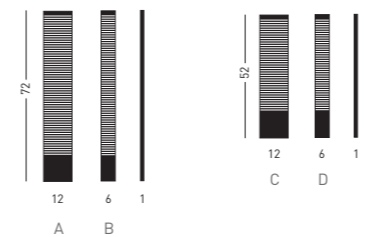

A	301/60	72 x 12	1	60
B	303/60	72 x 6	1	60
C	301/40	52 x 12	1	40
D	303/40	52 x 6	1	40

ES | Planning portafichas

Portafichas para fichas en forma "T" de cartulina, intercambiables y ampliables mediante la guía de sujeción a pared Ref.06. Disponibles en 2 formatos (6 ó 12 cm.), y dos tamaños (40 ó 60 fichas) respectivamente. Fichas 3003 y 3001 disponibles en 11 colores.

GB | Card planner

Card planner for "T" cards. Extendable through a wall subsection track placed at the base of the card planner (Ref. 06). Available in 2 formats (6 or 12 cm.) and 2 sizes (40 or 60 cards) respectively. Cards 3003 and 3001 are available in 11 different colours.

FR | Planning à fiches

Planning pour fiche en T en carton et de couleurs (11 couleurs). Composez facilement votre système, sur 2 formats de 6 ou 12 cm et deux dimensions de fiches 40 ou 60.

DE | Kartentafel für Karten

Kartentafel zur Wandbefestigung (Ref 06) mit festen, offenen Bahnen zur Aufnahme von Belegen oder Formularsätzen (T-Karten). Beliebig variabel kombinierbar. Erhältlich in zwei Formaten (6 oder 12 cm) und in zwei Größen (40 oder 60 Karten).

IT | Contenitore Planning

Porta carte a forma di "T". Estendibile grazie ad un binario posto alla base del porta carte (Ref. 06). Disponibile in 2 formati (6 o 12 cm.) e in 2 dimensioni (40 o 60 carte). Carte 3003 e 3001 sono disponibili in 11 diversi colori.

PO | Planning porta fichas

Porta fichas em forma de "T" em cartolina, amovíveis e ampliáveis, através de uma guia aplicada na parede Refª 06. Disponíveis em 2 formatos (6 ou 12 cm.) e 2 capacidades (40 ou 60 fichas) respectivamente. Fichas 3003 e 3001 disponíveis em 11 cores.

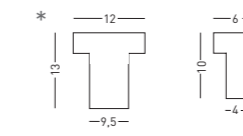

E	3001	13,5 x 12	50
	3003	10 x 6	50

	06/301	12
	06/303	6

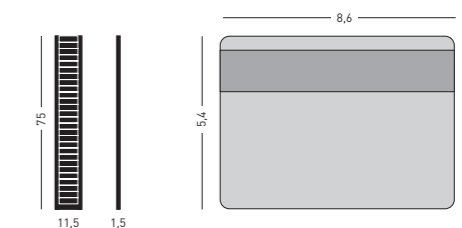

1	319	75 x 11,5	1,5	25
---	------------	-----------	-----	----