

01

Visualplan

- ES| Comunicación visual
- GB| Visual communication
- FR| Communication visuelle
- DE| Visuale Kommunikation
- IT| Comunicazione visuale
- PO| Comunicação visual



es| Comunicación visual
 La familia de productos VISUALPLAN comprende una amplia gama de artículos dirigidos al segmento de la Comunicación Visual. La pizarra blanca en todas sus variedades y calidades, cubre todos los segmentos de actuación en el mercado, desde la empresa y el home/office, pasando por la hostelería y el sector escolar. Oficinas, salas de formación, salas de reuniones, universidades y escuelas, son los principales objetivos de esta familia de producto.



fr| Communication visuelle
 Cette famille de produit a une large gamme axée sur la communication visuelle. Des tableaux blancs de tous types et de différentes qualités pour satisfaire tous les marchés qu'ils soient publics, privés, appels d'offre, scolaire... Les salles de formation, le bureau, les salles de réunion, universités ou les écoles sont les principaux objectifs de cette famille de produit.



it| Comunicazione visuale
 Questa famiglia di prodotti ha un'ampia gamma di articoli diretti al segmento della comunicazione visiva. E' composta da differenti tipi e qualità di lavagne che possono essere utilizzate sia nel pubblico che nel privato, gare, scuole, ecc... Uffici, sale corsi, sale meeting, università e scuole sono i principali target di questa famiglia di prodotti.

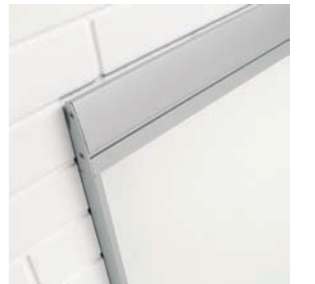

gb| Visual communication
 This product family has a broad range of items directed to the Visual Communication segment. It is composed of different types and qualities of whiteboards to meet all markets such as public and private areas, tenders, schools... Offices, training rooms, meeting rooms, universities and schools are the main targets of this products family.



de| Visuale Kommunikation
 Die Familie der Produkte VISUALPLAN schließt eine umfangreiche Produktpalette ein, die an die Visuelle Kommunikation Gruppe gerichtet werden. Whiteboards in einem ausgedehnten Produktportfolio und Qualitäten umfaßt die vollständigen Marktbranchen und reicht von Firmen home/office bis zur Hotelgeschäfte und Schulaktivitäten. Büros, Ausbildungsräume, Konferenzzimmer, Universitäten und Schulen sind die Hauptziele dieser Familie der Produkte.



po| Comunicação visual
 A família de produtos VISUALPLAN compreende uma ampla gama de artigos dirigidos ao segmento da Comunicação Visual. O quadro branco em todas as suas variedades e qualidades, cobre todos os segmentos de actuação no mercado, desde a empresa e casa/escritório, passando pela hotelaria e o sector escolar. Escritórios, salas de formação, salas de reuniões, universidades e escolas, são os principais objectivos desta família de produtos.



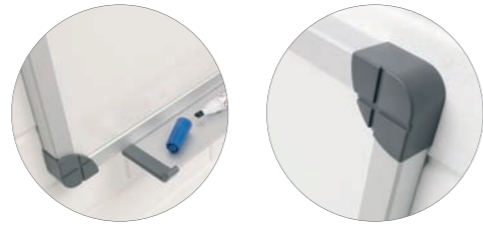

A	↑	→	⊗
725/1	40 x 60	2,2	30
725/2	60 x 80	2,2	30
725/3	80 x 120	2,2	30
725/4	100 x 120	2,2	30
725/5	120 x 150	2,2	30
725/6	120 x 175	2,2	30
725/7	120 x 200	2,2	30
725/8	120 x 250	2,2	30
725/9	120 x 300	2,2	30

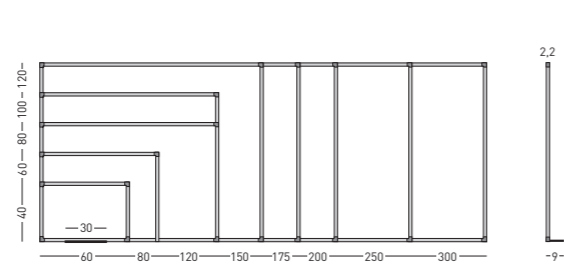

*B	↑	→	⊗
725/4/M	100 x 120	2,2	30
725/5/M	120 x 150	2,2	30
725/6/M	120 x 175	2,2	30
725/7/M	120 x 200	2,2	30
725/8/M	120 x 250	2,2	30
725/9/M	120 x 300	2,2	30

* Solo para trazo digital. Superficie mate.
* Only for digital stroke. Matt surface.

es | Pizarra mural laminada
Pizarra mural blanca enmarcada con perfil de aluminio anodizado en color plata mate y cantoneras redondeadas de plástico gris. Superficie laminada rotulable en seco. Incluye cajetín reposarrotuladores de 30 cm.

fr | Tableau blanc stratifié
Tableau blanc stratifié avec encadrement en aluminium anodisé couleur argent aux coins arrondis en plastique gris. Surface mélaminée effaçable à sec. Livré avec un auget porte marqueurs de 30 cm.

it | Lavagna da muro bianca
Lavagna bianca con cornice in alluminio anodizzato naturale ed angoli grigi in plastica, superficie scrivibile con pennarelli a secco. Porta pennarelli da 30cm. Incluso.

es | Laminated whiteboard
Whiteboard equipped with silver anodised aluminium frame and grey plastic rounded corners. Surface is laminated and suitable for writing with dry wipe board markers. A 30 cm. pen tray included.

de | Laminierte Whiteboard
Whiteboard mit anodisiertem Aluminiumrahmen silber eloxiert und abgerundeten grauen Kunststoffecken. Laminierte Schreibtafelberfläche mit trocken abwischbaren Boardmarkern beschreibbar. Lieferung inkl.: Stiftablage 30 cm. lang.

pt | Quadro de parede branco laminado
Quadro de parede branco com perfil de alumínio anodizado na cor prata mate e cantos arredondados em plástico cinzento. Superfície laminada para escrita com marcadores. Inclui suporte para marcadores com 30 cm.

A
rail

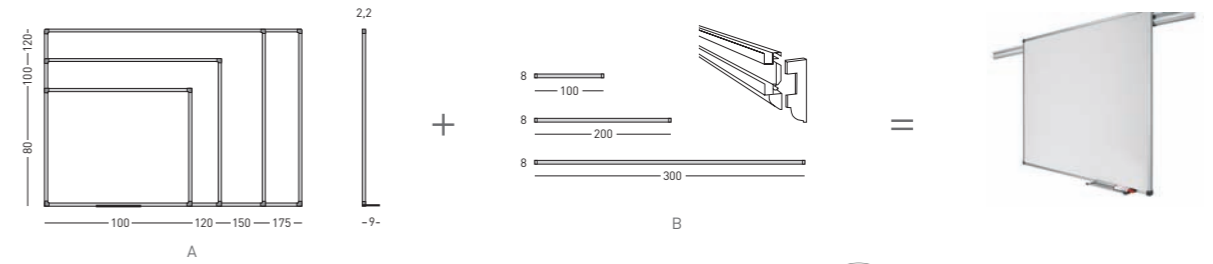

A	↑	→	⊗
725/3	80 x 100	2,2	30
725/4	100 x 120	2,2	30
725/5	100 x 150	2,2	30
725/6	100 x 175	2,2	30

B	↑	→	⊗
RP/000	-	8	
RP/100	100	8	
RP/200	200	8	
RP/300	300	8	

RP/L 5 x 8 90°

RP/30 2,5 5

pg. 36-37

B
T

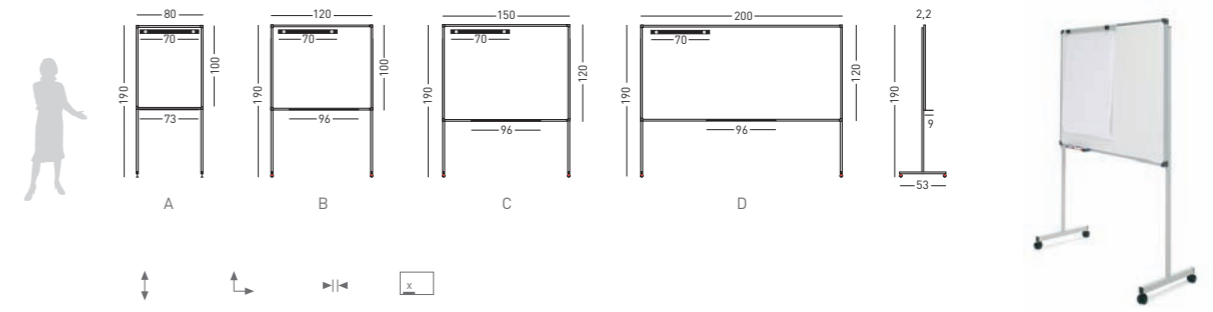

A	↑	→	⊗
705/L	190	100 x 80	2,2 73
706/L	190	100 x 120	2,2 96
713/L	190	100 x 150	2,2 96
714/L	190	120 x 200	2,2 96

pg. 34



C
delta

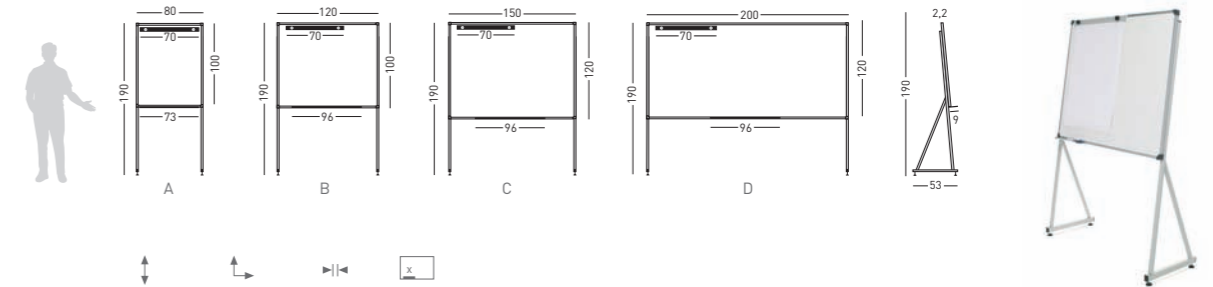

A	↑	→	⊗
707/L	190	100 x 80	2,2 73
708/L	190	100 x 120	2,2 96
715/L	190	100 x 150	2,2 96
716/L	190	120 x 200	2,2 96

pg. 35



X
acces



pg. 56-57

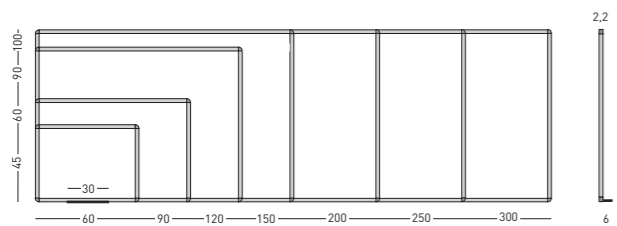

A	Dimensions	Height	Depth
722/1	45 x 60	2,2	30
722/2	60 x 90	2,2	30
722/3	90 x 120	2,2	30
722/5	100 x 150	2,2	30
722/6	100 x 200	2,2	30
722/7	100 x 250	2,2	30
722/8	100 x 300	2,2	30

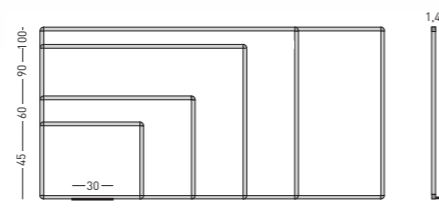

B	Dimensions	Height	Depth
BL/VI/0010	45 x 60	1,4	30
BL/VI/0011	60 x 90	1,4	30
BL/VI/0012	90 x 120	1,4	30
BL/VI/0013	100 x 150	1,4	30
BL/VI/0014	100 x 200	1,4	30

es | Pizarra mural lacada
Pizarra mural blanca enmarcada con perfil de aluminio anodizado en color plata mate y cantoneras redondeadas de plástico gris. Superficie magnética lacada rotulable en seco. Incluye cajetín reposarrotuladores de 30 cm.

fr | Tableau blanc laqué
Tableau blanc laqué avec encadrement en aluminium anodisé couleur argent aux coins arrondis en plastique gris. Surface laquée magnétique effaçable à sec. Livré avec auget porte marqueurs 30 cm.

it | Lavagna da muro laccata bianca
Lavagna bianca con cornice in alluminio anodizzato naturale ed angoli grigi in plastica, magnetica, superficie scrivibile con pennarelli a secco. Porta pennarelli da 30 cm. Incluso.

gb | Lacquered whiteboard
Whiteboard equipped with silver anodised aluminium frame and grey plastic rounded corners. Magnetic attachable, lacquered surface suitable for writing with dry wipe board markers. A 30 cm. pen tray included.

de | Weisse Wandtafel
Weisse Wandtafel mit anodisiertem Aluminiumrahmen, silbereloxiert, mit abgerundeten Kunststoffecken. Lackierte, magnetische Oberfläche geeignet für Trockenbeschriftung, Stiftablage von 30cm.

pt | Quadro branco de parede lacado
Quadro de parede branco com perfil de alumínio anodizado na cor prata mate e cantos arredondados em plástico cinzento. Superfície magnética lacada para escrita com marcadores. Inclui suporte para marcadores com 30 cm.

A
rail

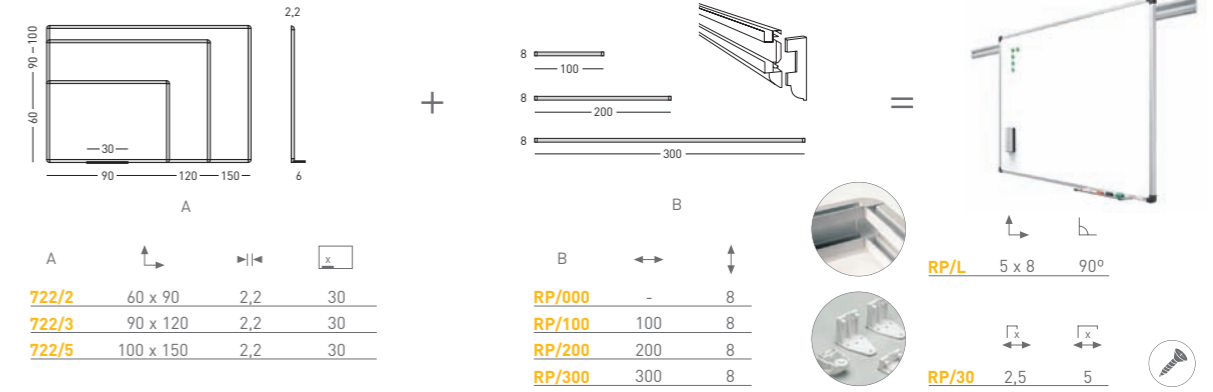

pg. 36-37

B
T

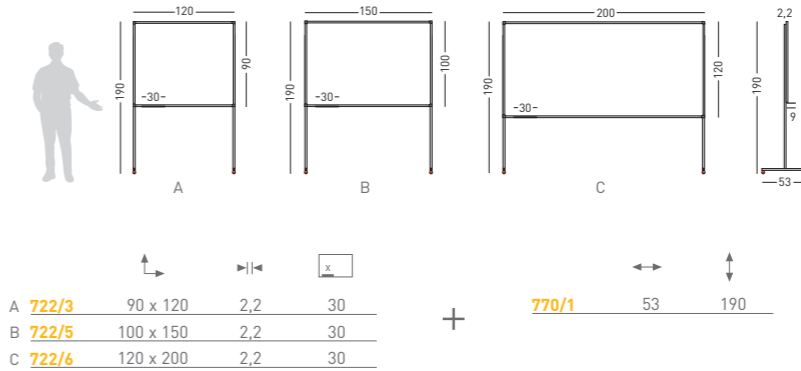

pg. 34

C
Delta

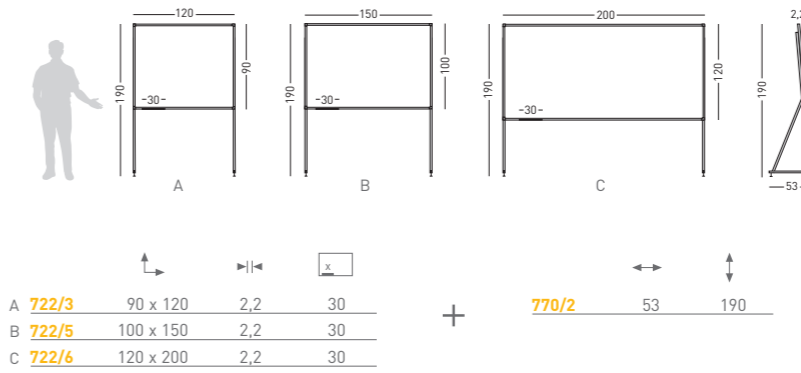

pg. 35

D
Y2

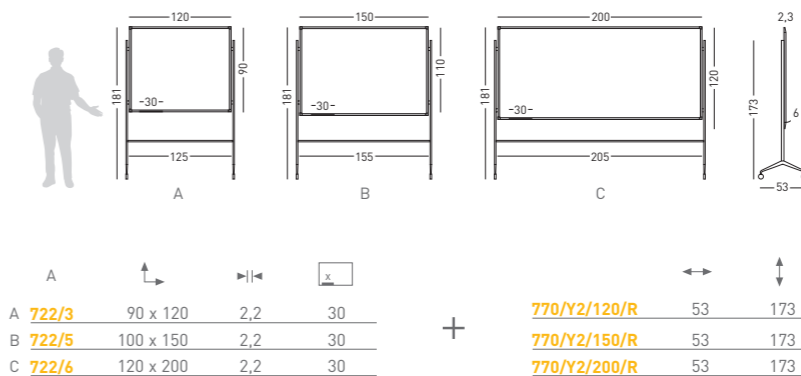

pg. 34



A	↑	→	⊗
720/10	40 x 60	2,2	30
720/1	60 x 80	2,2	30
720/2	80 x 100	2,2	30
720/3	100 x 120	2,2	30
720/4	100 x 150	2,2	30
720/5	100 x 175	2,2	30
720/6	120 x 200	2,2	30
720/7	120 x 250	2,2	30
720/8	120 x 300	2,2	30
720/9	120 x 400	2,2	30

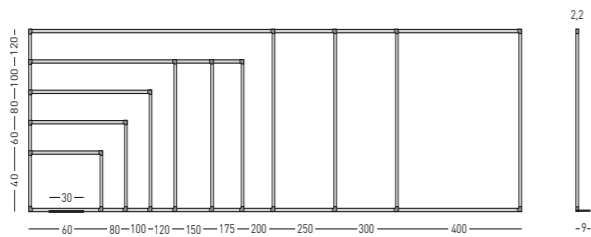

*B	↑	→	⊗
720/10/M	40 x 60	2,2	30
720/1/M	60 x 80	2,2	30
720/2/M	80 x 100	2,2	30
720/3/M	100 x 120	2,2	30
720/4/M	120 x 150	2,2	30
720/5/M	120 x 180	2,2	30
720/6/M	120 x 200	2,2	30
720/7/M	120 x 250	2,2	30
720/8/M	120 x 300	2,2	30
720/9/M	120 x 400	2,2	30

* Superficie mate para proyección.
* Matt surface projection screen.

es | Pizarra mural acero vitrificado
Pizarra mural blanca enmarcada con perfil de aluminio anodizado en color plata. Superficie magnética de acero vitrificado a 800° C con garantía de por vida. Ref. /M - versión mate apta para proyectar. Rotulable en seco. Incluye cajetín de 30 cm.

fr | Tableau émaillé
Tableau émaillé blanc avec encadrement en aluminium anodisé couleur argent aux coins arrondis en plastique. Surface magnétique émaillée vitrifiée à 800° C "Garantie à vie". Ref. /M - blanc pour projection. Livré avec auget porte marqueurs de 30 cm.

it | Lavagna a muro bianca smaltata
Lavagna bianca con cornice in alluminio anodizzato naturale ed angoli grigi in plastica, magnetica, smaltata ad 800° e garantita a vita. Superficie scrivibile con pennarelli a secco. Ref. /M - versione opaca a proiezione. Porta pennarelli da 30 cm. Incluso.

es | Enamelled whiteboard
Whiteboard equipped with silver anodised aluminium frame and plastic rounded corners. 800° C "Life-time Guarantee". Enamelled surface suitable for writing with dry wipe board markers. Ref. /M - matt version for projection. A 30 cm. pen tray.

de | Emailierte Whiteboard
Whiteboard mit anodisiertem Aluminiumrahmen, silbereloxiert, mit abgerundeten Kunststoffecken. Magnethaftend, gehärtet bei 800° Celsius, geeignet für Trockenbeschriftung mit allen gängigen Markern, unbegrenzte Garantie, Stiftablage von 30cm.

pt | Quadro branco aço vitrificado
Quadro de parede branco com perfil em alumínio anodizado na cor prata mate e cantos arredondados em plástico. Superfície magnética em aço vitrificado a 800° C com garantia vitalícia. Ref. /M - versão mate que permite projectar. Inclui suporte com 30 cm.

A
rail

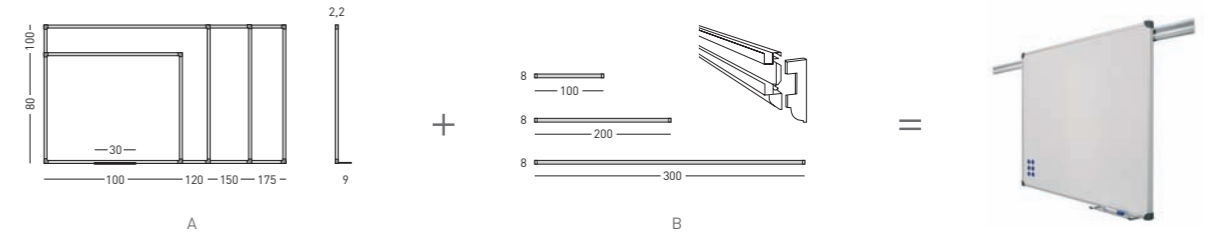

A	↑	→	⊗
720/2	80 x 100	2,2	30
720/3	100 x 120	2,2	30
720/4	100 x 150	2,2	30
720/5	100 x 175	2,2	30

B	↑	→	⊗
RP/000	-	8	
RP/100	100	8	
RP/200	200	8	
RP/300	300	8	



pg. 36-37

B
T

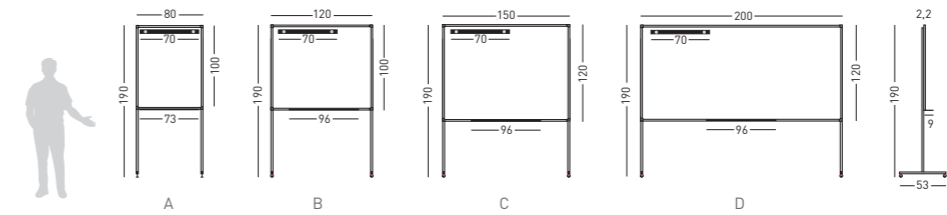

A	↑	→	⊗
705/A	190	100 x 80	2,2 73
706/A	190	100 x 120	2,2 96
713/A	190	100 x 150	2,2 96
714/A	190	120 x 200	2,2 96

pg. 34



C
delta

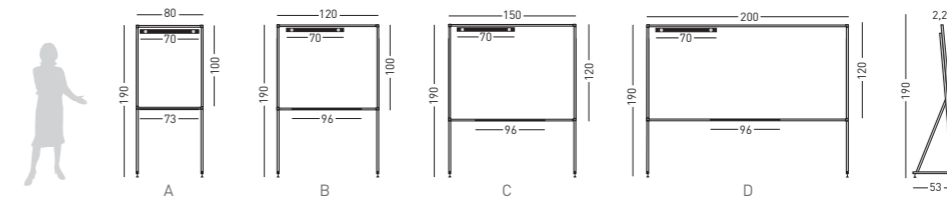

A	↑	→	⊗
707/A	190	100 x 80	2,2 73
708/A	190	100 x 120	2,2 96
715/A	190	100 x 150	2,2 96
716/A	190	120 x 200	2,2 96

pg. 35



X
acces



pg. 56-57

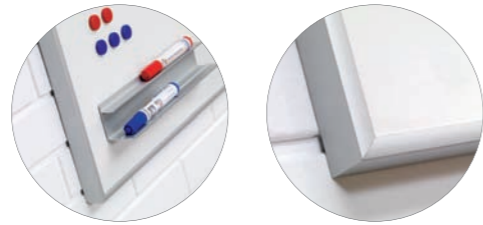

A	↑	→	x
724/10	40 x 60	2,3	30
724/1	60 x 80	2,3	30
724/2	80 x 100	2,3	30
724/3	100 x 120	2,3	30
724/4	100 x 150	2,3	30
724/5	100 x 175	2,3	30
724/6	120 x 200	2,3	30

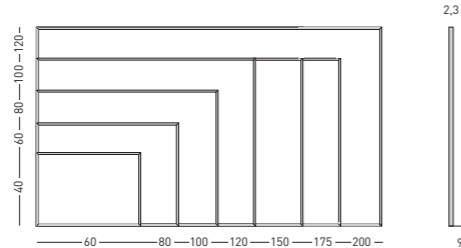

B	↑	→	x
724/10/LC	45 x 60	2,3	30
724/1/LC	60 x 90	2,3	30
724/2/LC	80 x 100	2,3	30
724/3/LC	90 x 120	2,3	30
724/4/LC	100 x 150	2,3	30
724/5/LC	100 x 175	2,3	30
724/6/LC	100 x 200	2,3	30

ES | Pizarra acero vitrificado marco "Mini"
Pizarra mural blanca enmarcada a inglete con perfil de aluminio anodizado "Mini" en color plata mate. Superficie magnética de acero vitrificado a 800°C con garantía de por vida. Rotulable en seco. Incluye cajetín reposarrotuladores de 30 cm.

FR | Tableau émaillé blanc "Mini"
Tableau blanc mural avec encadrement à angles droit en aluminium anodisé "Mini" de couleur argent. Surface magnétique émaillée et vitrifiée à 800°C garantie à vie. Effaçable à sec. Livré avec auget porte marqueurs de 30 cm.

IT | Lavagna smaltata con cornice "Mini"
Lavagna con cornice perimetrale in alluminio anodizzato "Mini" con angoli vivi. Superficie smaltata a 800° e garantita a vita. Superficie scrivibile con pennarelli a secco. Porta pennarelli da 30 cm. Incluso.

GB | Enamel whiteboard "Mini"
Whiteboard equipped with matt silver anodised "Mini" aluminium frame and mitred corners. Lifetime guarantee and magnetic attachable 800°C enamel surface. Suitable for writing with dry wipe board markers. A 30 cm. pen tray included.

DE | Emailierte Whiteboard-Tafel "Mini"
Whiteboard Wand-Tafel mit einem matt silver anodisierten auf Gehrung Aluminiumrahmen. Magnethaftende emailierte 800°C "Life-time Guarantee". Schreibtafeloberfläche mit trocken abwischbaren Boardmarkern beschreibbar.

PO | Quadro de aço vitrificado aro "Mini"
Quadro de parede branco com perfil em alumínio anodizado "Mini" na cor prata mate. Superfície magnética em aço vitrificado a 800° C com garantia vitalícia. Superfície para escrita com marcadores. Inclui suporte para marcadores com 30 cm.

A
rail

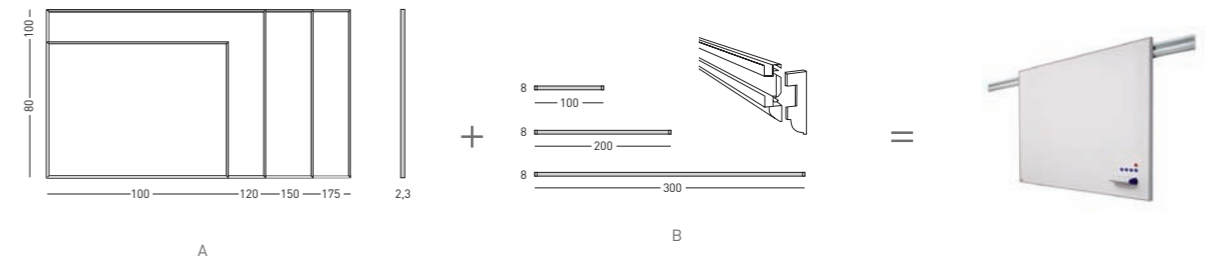

A	↑	→	x
724/2	80 x 100	2,3	30
724/3	100 x 120	2,3	30
724/4	100 x 150	2,3	30
724/5	100 x 175	2,3	30

B	↑	→
RP/000	-	8
RP/100	100	8
RP/200	200	8
RP/300	300	8

RP/L	↑	→
5 x 8	90°	
RP/30	2,5	5

pg. 36-37

B
T

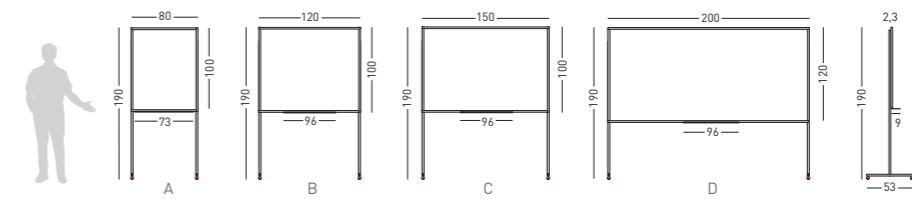

A	↑	→	x
724/T2	190	100 x 80	2,3 73
724/T3	190	100 x 120	2,3 96
724/T4	190	100 x 150	2,3 96
724/T6	190	120 x 200	2,3 96

pg. 34



C
delta

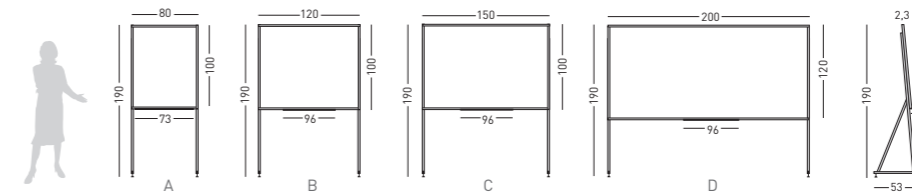

A	↑	→	x
724/D2	190	100 x 80	2,3 73
724/D3	190	100 x 120	2,3 96
724/D4	190	100 x 150	2,3 96
724/D6	190	120 x 200	2,3 96

pg. 35



D
Y2

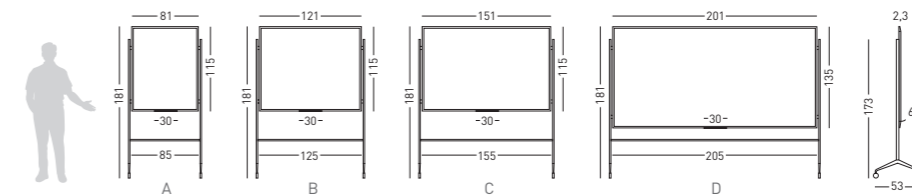

A	↑	→	x
724/Y2	181	100 x 80	2,3 80
724/Y3	181	100 x 120	2,3 96
724/Y4	181	100 x 150	2,3 96
724/Y6	181	120 x 200	2,3 96

pg. 34





A
T

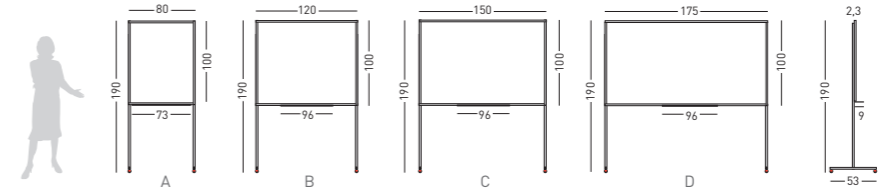

	Height	Width	Depth	Tray
A 728/M2/T	190	100 x 80	2,3	30
B 728/M3/T	190	100 x 120	2,3	30
C 728/M4/T	190	100 x 150	2,3	30
D 728/M5/T	190	100 x 175	2,3	30

pg. 34



B
delta

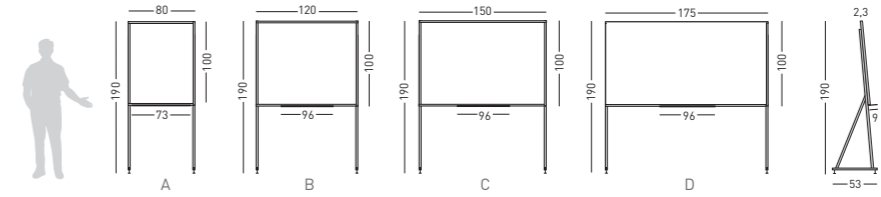

	Height	Width	Depth	Tray
A 728/M2/D	190	100 x 80	2,3	30
B 728/M3/D	190	100 x 120	2,3	30
C 728/M4/D	190	100 x 150	2,3	30
D 728/M5/D	190	100 x 175	2,3	30

pg. 35



C
Y2

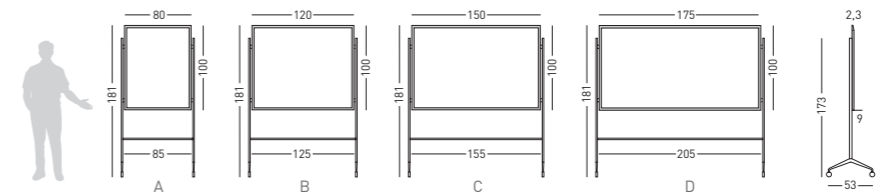

	Height	Width	Depth	Tray
A 728/M2/Y	181	100 x 80	2,3	30
B 728/M3/Y	181	100 x 120	2,3	30
C 728/M4/Y	181	100 x 150	2,3	30
D 728/M5/Y	181	100 x 175	2,3	30

pg. 34

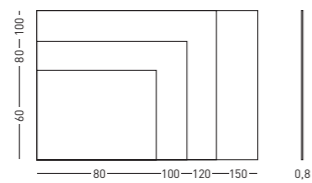

Model	Height	Width	Depth
728/1	60	80	0,8
728/2	80	100	0,8
728/3	100	120	0,8
728/4	100	150	0,8

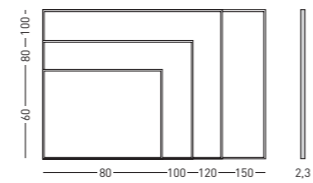

Model	Height	Width	Depth	Tray
728/M1	60	80	2,3	30
728/M2	80	100	2,3	30
728/M3	100	120	2,3	30
728/M4	100	150	2,3	30

ES | Pizarra mural de vidrio

Pizarra de vidrio laminado de 4+4 mm, traslúcido sin marco. Superficie rotulable con rotuladores de borrado en seco. Incorpora elementos de fijación a pared. La versión con soporte lleva marco de aluminio.

FR | Tableau mural en verre

Tableau en verre laminé 4+4 mm, surface pour feutre effaçables a sec, livré avec les éléments de fixation murale. La référence sur pied a un cadre en aluminium.

IT | Lavagna da parete in vetro

Lavagna in vetro laminato 4+4 mm, senza cornice. Superficie adatta per la scrittura con pennarelli pulizia a secco. La versione con supporto include il profilo in alluminio.

GB | Glass board

Traslucid laminated 4+4 mm, thick glass board without frame. Surface is suitable for writing with dry wipe board markers. Wall-mounted brackets are included. The supported version includes aluminium frames.

DE | Glaswandtafel

Laminierte durchsichtige Glaswandtafel 4+4 mm, ohne Rahmen. Die Oberfläche kann mit Boardmarkern beschriftet werden. Aufhängevorrichtung für die Wand vorhanden. Die unterstützte Version beinhaltet einen Aluminiumrahmen.

PO | Quadro de parede em vidro

Quadro em vidro laminado com 4+4 mm, translúcido sem perfil. Superfície para escrita com marcadores. Inclui elementos de fixação à parede. A versão com suporte tem um perfil em alumínio.

X
acces



pg. 56-57

720-C
PS design

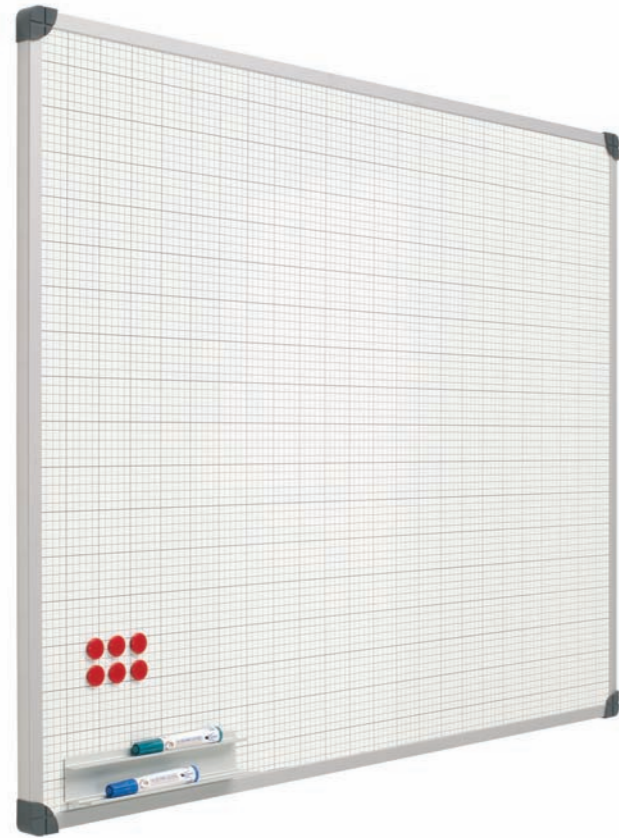
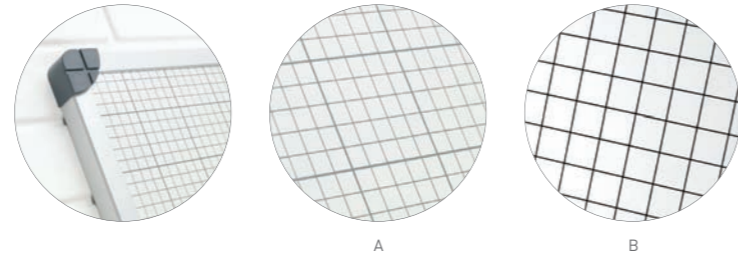

A				B				
Grid	Dimensions	Weight	Depth	Grid	Dimensions	Weight	Depth	
1 x 1 cm.	720/C1	45 x 60	2,2	30	725/C1	120 x 100	2,2	30
5 x 5 cm.	720/C2	60 x 90	2,2	30	725/C2	120 x 150	2,2	30
	720/C3	90 x 120	2,2	30	725/C3	120 x 200	2,2	30
	720/C4	120 x 180	2,2	30	725/C4	120 x 300	2,2	30

ES | Pizarra mural cuadrículada
Pizarra mural blanca cuadrículada con perfil de aluminio anodizado en color plata mate y cantoneras redondeadas de plástico gris. Superficie rotulable en seco. Incluye cajetín reposarrotuladores de 30 cm.

FR | Tableau blanc quadrillé
Tableau blanc quadrillé avec encadrement en aluminium anodisé couleur argent aux coins arrondis en plastique gris. Surface effaçable à sec. Livré avec un auget porte marqueurs de 30 cm.

IT | Lavagna a quadretti smaltata
Lavagna a quadretti con cornice in alluminio anodizzato naturale ed angoli grigi in plastica. Superficie scrivibile con pennarelli a secco. Porta pennarelli da 30 cm. Incluso.

GB | Grided whiteboards
Grided Whiteboard equipped with silver anodised aluminium frame and grey plastic rounded corners. Surface is suitable for writing with dry wipe board markers. A 30 cm. pen tray included.

DE | Rastertafel
Rastertafel mit anodisiertem Aluminiumrahmen, silber eloxiert und abgerundeten grauen Kunststoffecken. Schreibtafeloberfläche mit trocken abwischbaren Boardmarkern beschreibbar. Lieferung inkl.: Stiftablage 30 cm. lang.

PO | Quadro quadriculado
Quadro de parede branco quadriculado com perfil de alumínio anodizado na cor prata mate e cantos arredondados em plástico cinzento. Superfície branca para escrita com marcadores. Inclui suporte para marcadores com 30 cm.

A
rail

Model	Dimensions	Weight	Depth
720/C3	90 x 120	2,2	30
720/C4	120 x 180	2,2	30
725/C1	100 x 120	2,2	30
725/C2	120 x 150	2,2	30

Model	Dimensions	Weight	Depth
RP/000	-	8	-
RP/100	100	8	-
RP/200	200	8	-
RP/300	300	8	-

pg. 36-37

B
T

Model	Dimensions	Weight	Depth
720/C3/T	190	90 x 120	2,2
720/C4/T	190	120 x 180	2,2
725/C1/T	190	100 x 80	2,2
725/C2/T	190	100 x 120	2,2
725/C3/T	190	100 x 150	2,2
725/C4/T	190	120 x 200	2,2

pg. 34

C
delta

Model	Dimensions	Weight	Depth
720/C3/D	190	90 x 120	2,2
720/C4/D	190	120 x 180	2,2
725/C1/D	190	100 x 80	2,2
725/C2/D	190	100 x 120	2,2
725/C3/D	190	100 x 150	2,2
725/C4/D	190	120 x 200	2,2

pg. 35

X
acces



pg. 56-57

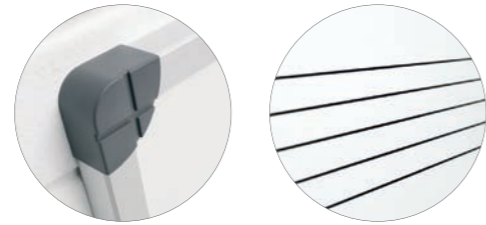

A	↑	↖	↗	x
720/P1	120 x 150	2,2	30	
720/P2	120 x 200	2,2	30	
720/P3	120 x 300	2,2	30	

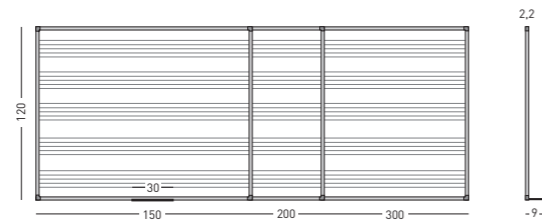

B	↑	↖	↗	x
725/P1	120 x 150	2,2	30	
725/P2	120 x 200	2,2	30	
725/P3	120 x 300	2,2	30	



es | Pizarra pentagrama
Pizarra mural blanca de pentagrama enmarcada con perfil de aluminio anodizado en color plata mate y cantoneras redondeadas de plástico gris. Superficie rotulable en seco. Incluye cajetín reposarrotuladores de 30 cm. Tiene 5 pentagramas serigrafiados en negro.

fr | Tableau blanc pentagramme
Tableau blanc pentagramme avec encadrement en aluminium anodisé couleur argent aux coins arrondis en plastique gris. Surface d'écriture effaçable à sec. Livré avec un auget porte marqueurs de 30 cm. Avec 5 pentagrammes serigraphiés en noir.

it | Lavagna a pentagramma smaltata
Lavagna a pentagramma con cornice in alluminio anodizzato naturale ed angoli grigi in plastica. Superficie scrivibile con pennarelli a secco. Porta pennarelli da 30cm. Incluso. Con 5 pentagramma neri.

es | Pentagram whiteboard
Pentagram Whiteboard equipped with silver anodised aluminium frame and grey plastic rounded corners. Surface is suitable for writing with dry wipe board markers. A 30 cm. pen tray included. With 5 serigraphed black pentagrams.

de | Pentagrammtafel
Pentagrammtafel mit anodisiertem Aluminiumrahmen, silber eloxiert und runden grauen Kunststoffecken. Oberfläche mit trocken abwischbaren Boardmarkern beschreibbar. Lieferung inkl.: Stiftablage 30 cm. lang, 5 schwarze Pentagramme.

pt | Quadro pautado
Quadro de parede branco pautado com perfil de alumínio anodizado na cor prata mate e cantos arredondados em plástico cinzento. Superfície branca para escrita com marcadores. Inclui suporte para marcadores com 30 cm. Tem 5 linhas na cor preta.

A
rail

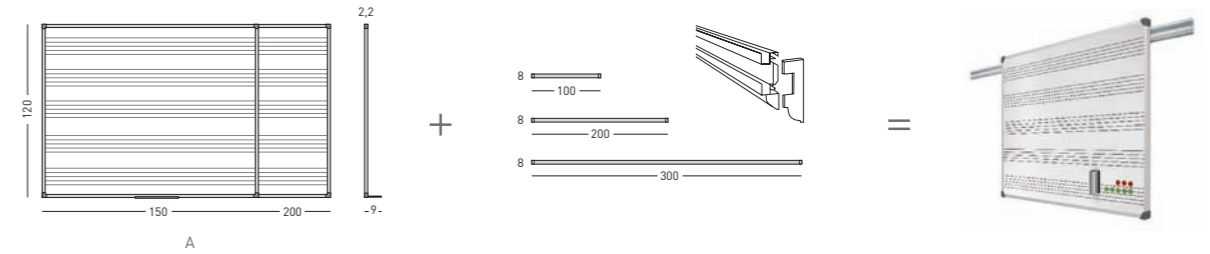

A	↑	↖	↗	x
720/P1	120 x 150	2,2	30	
725/P2	120 x 200	2,2	30	

RP/000	↑	↖	↗	↘
RP/000	-	8		
RP/100	100	8		
RP/200	200	8		
RP/300	300	8		



pg. 36-37

B
T

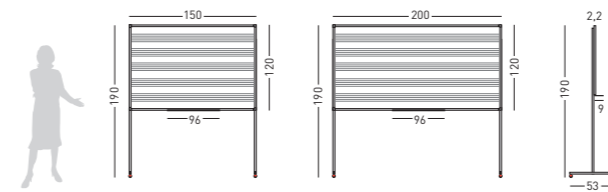

A	↑	↖	↗	↘
720/P1/T	190	120 x 150	2,2	
720/P2/T	190	120 x 200	2,2	

B	↑	↖	↗	↘
725/P1/T	190	120 x 150	2,2	
725/P2/T	190	120 x 200	2,2	



pg. 34

C
delta

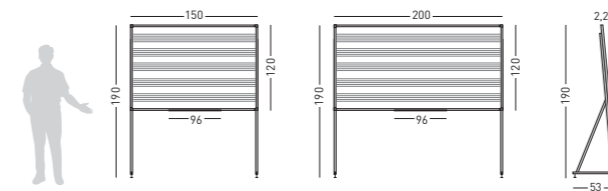

A	↑	↖	↗	↘
720/P1/D	190	120 x 150	2,2	
720/P2/D	190	120 x 200	2,2	

B	↑	↖	↗	↘
725/P1/D	190	120 x 150	2,2	
725/P2/D	190	120 x 200	2,2	



pg. 35

X
acces



pg. 56-57



22



*A	↕	↔	↖	↗	⊠
Z/720/1	60 x 80	73 x 81	2,3	30	
Z/720/2	80 x 100	93 x 101	2,3	30	
Z/720/3	100 x 120	113 x 121	2,3	30	
Z/720/4	100 x 150	113 x 151	2,3	30	
Z/720/5	100 x 175	113 x 176	2,3	30	
Z/720/6	120 x 200	133 x 201	2,3	30	
Z/720/7	120 x 250	133 x 251	2,3	30	

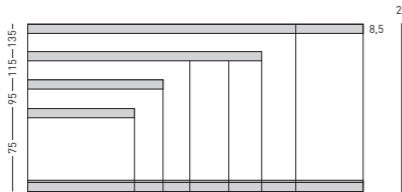

*B	↕	↔	↖	↗	⊠
Z/725/1	60 x 80	73 x 81	2,3	30	
Z/725/2	80 x 100	93 x 101	2,3	30	
Z/725/3	100 x 120	113 x 121	2,3	30	
Z/725/4	120 x 150	113 x 151	2,3	30	
Z/725/5	120 x 175	113 x 176	2,3	30	
Z/725/6	120 x 200	133 x 201	2,3	30	
Z/725/7	120 x 250	133 x 251	2,3	30	

ES | Pizarra blanca "Zénit" de acero vitrificado
Pizarra mural Zénit enmarcada con perfil de aluminio anodizado en color plata mate (tapa personalizable). Superficie laminada rotulable en seco. Incluye cajetín reposarrotuladores de 30 cm.

FR | Tableau Blanc "Zénit" acier émaillé
Tableau blanc en acier émaillé avec encadrement aluminium anodisé (personnalisable). Livré avec auget porte-marqueur 30 cm.

IT | Lavagna bianca "Zénit" Acciaio Vetrificato
Lavagna bianca da parete Zenit con cornice in alluminio anodizzato colore argento opaco (personalizzabile). Include cofanetto portaccessori.

GB | Enamelled steel Whiteboard "Zénit"
Enamelled steel whiteboard with anodized aluminium frame (customizable). Included a marker-holder 30 cm.

DE | Emalierte weiße "Zénit" Stahlwandtafel
Güne Wandtafel "Zénit", mit einem mattsilbernen, anodisiertem Aluminiumrahmen (individuelle Abdeckung), beschichtete Oberfläche geeignet für Trockenbeschriftung, Stiftablage von 30cm.

PO | Quadro branco "Zénit" em Aço Vitrificado
Quadro branco Zénit, com perfil em alumínio anodizado na cor prata mate (tampas personalizáveis). Inclui suporte para marcadores.

A
rail

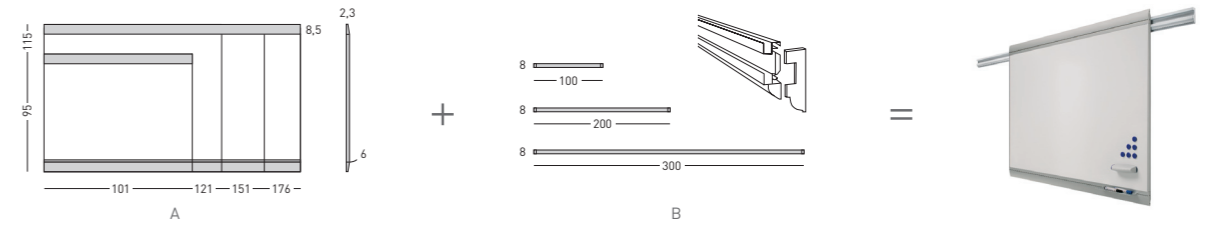

A	↕	↔	↖	↗	⊠
Z/720/2	80 x 100	93 x 101	2,3	30	
Z/720/3	100 x 120	113 x 121	2,3	30	
Z/720/4	100 x 150	113 x 151	2,3	30	
Z/720/5	100 x 175	113 x 176	2,3	30	

B	↕	↔	↖	↗	⊠
RP/000	-	8			
RP/100	100	8			
RP/200	200	8			
RP/300	300	8			

RP/L	↕	↔	↖	↗	⊠
5 x 8	90°				
RP/30	2,5	5			

pg. 36-37

B
Y2

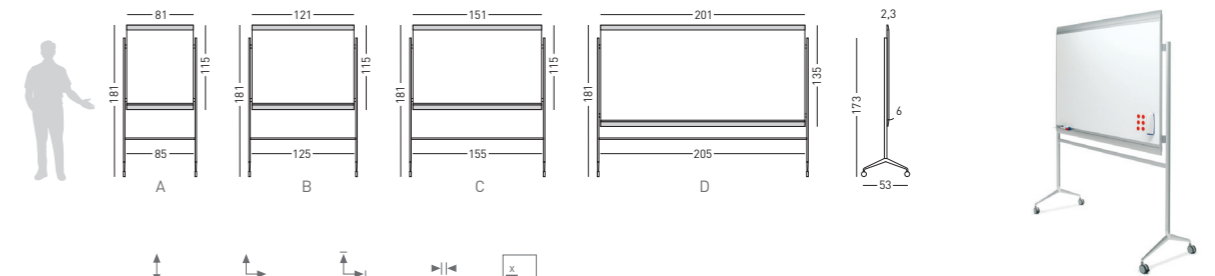

A	↕	↔	↖	↗	⊠
Z/720/Y2	181	100 x 80	113 x 81	2,3	30
B Z/720/Y3	181	100 x 120	113 x 121	2,3	30
C Z/720/Y4	181	100 x 150	113 x 151	2,3	30
D Z/720/Y6	181	120 x 200	133 x 201	2,3	30

pg. 34



C
/C - /P

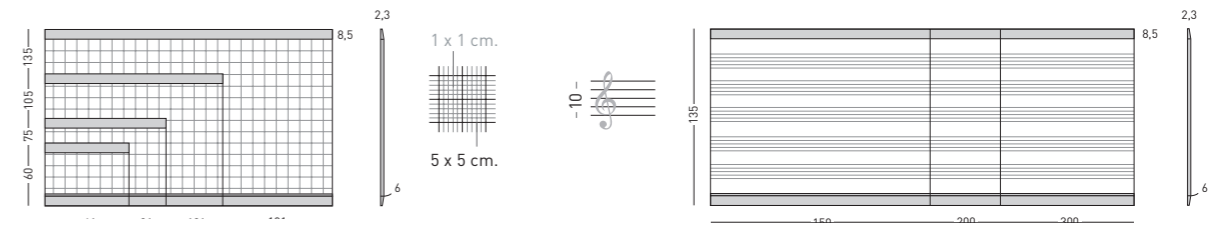

Z/720/C1	↕	↔	↖	↗	⊠
45 x 60	58 x 61	2,3	30		
Z/720/C2	60 x 90	73 x 91	2,3	30	
Z/720/C3	90 x 120	103 x 121	2,3	30	
Z/720/C4	120 x 180	133 x 181	2,3	30	

Z/720/P1	↕	↔	↖	↗	⊠
120 x 150	133 x 151	2,3	30		
Z/720/P2	120 x 200	133 x 201	2,3	30	
Z/720/P3	120 x 300	133 x 301	2,3	30	



X
aces



pg. 56-57

23

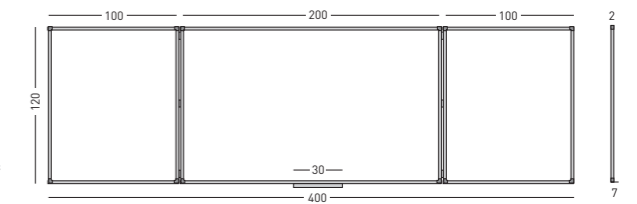
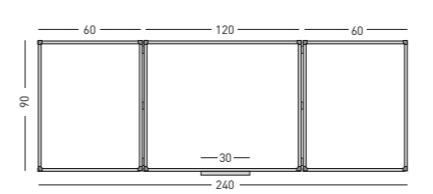
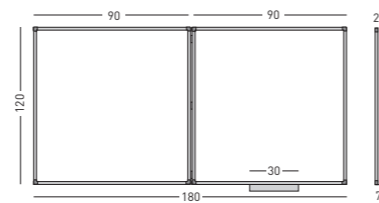
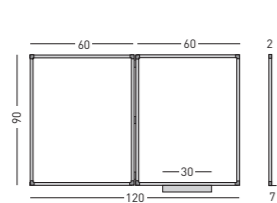

720/D1 90 x 120 90 x 60 2 + 2 30

720/D2 120 x 180 120 x 90 2 + 2 30

720/T1 90 x 240 90 x 120 2 + 4 30

720/T2 120 x 400 120 x 200 2 + 4 30

ES | Pizarra díptica

Pizarra mural blanca díptica de acero vitrificado enmarcada con perfil de aluminio anodizado en color plata mate y cantoneras redondeadas de plástico gris. Superficie rotulable en seco. Posee 3 superficies de escritura. Incluye cajetín de 30 cm.

FR | Tableau dyptique

Tableau blanc en acier émaillé, dyptique avec encadrement en aluminium anodisé couleur argent aux coins arrondis en plastique gris. Surface d'écriture effaçable à sec. Le deux panneaux offrent 3 surfaces d'écriture. Livré avec un auget de 30 cm.

IT | Lavagna doppia

Lavagna bianca con cornice in alluminio anodizzato naturale ed angoli grigi in plastica, magnetica, superficie scrivibile con pennarelli a secco. Il doppio pannello permette n. 03 superfici scrivibili. Porta pannarelli da 30 cm. incluso.

ES | Pizarra tríptica

Pizarra mural blanca tríptica de acero vitrificado enmarcada con perfil de aluminio anodizado en color plata mate y cantoneras redondeadas de plástico gris. Superficie rotulable en seco. Posee 5 superficies de escritura. Incluye cajetín reposarrotuladores de 30 cm.

FR | Tableau tryptique

Tableau tryptique en acier émaillé magnétique blanc avec encadrement en aluminium anodisé couleur argent aux coins arrondis en plastique gris. Surface d'écriture effaçable à sec. Les 3 panneaux offrent 5 surfaces d'écriture. Livré avec un auget de 30 cm.

IT | Lavagna tripla smaltata

Lavagna bianca con cornice in alluminio anodizzato naturale ed angoli grigi in plastica, magnetica, superficie scrivibile con pennarelli a secco. Il tripla pannello permette n. 05 superfici scrivibili. Porta pannarelli da 30 cm. incluso.

GB | Double paneled whiteboard

Whiteboard equipped with silver anodised aluminium frame and grey plastic rounded corners. Surface is suitable for writing with dry wipe board markers. The double panel gives for 3 separate writing surfaces. A 30 cm. pen tray is included.

DE | Klapptafel Zweiteilig

Zweiwandtafel mit anodisiertem Aluminiumrahmen, silber eloxiert und abgerundeten grauen Kunststoffecken. Die drei hochwertigen Weißwandtafel-Oberflächen sind mit trocken abwischbaren Boardmarkern beschreibbar. Lieferung inkl. Stiftablege 30 cm. lang.

PO | Quadro díptico

Quadro de parede branco díptico com perfil de alumínio anodizado na cor prata mate e cantos arredondados em plástico cinzento. Superfície branca para escrita com marcadores. Possui 3 superfícies de escrita. Inclui suporte para marcadores com 30 cm.

GB | Triple paneled whiteboard

Triple panelled whiteboard equipped with silver anodised aluminium frame and grey plastic rounded corners. Surface is suitable for writing on with dry-wiped board markers. The triple panel gives for 5 separate writing surfaces. A 30 cm. pen tray is included.

DE | Klapptafel Dreiteilig

Klapptafel mit anodisiertem Aluminiumrahmen, silber eloxiert und abgerundeten grauen Kunststoffecken. Die fünf hochwertigen Weißwandtafel-Oberflächen sind mit trocken abwischbaren Boardmarkern beschreibbar. Lieferung inkl. Stiftablege 30 cm. lang.

PO | Quadro tríptico

Quadro de parede branco tríptico com perfil de alumínio anodizado na cor prata mate e canto arredondados em plástico cinzento. Superfície branca para escrita com marcadores. Possui 5 superfícies de escrita. Inclui suporte para marcadores com 30 cm.



	↑	↖	↗
720/2/VV1	265	120 x 200	12
720/2/VV2	265	120 x 250	12
720/2/VV3	265	120 x 300	12
720/2/VV4	265	120 x 400	12

* Consultar medidas especiales.
* Ask us for special sizes.

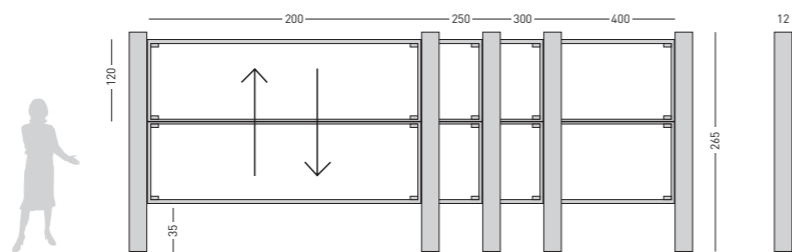

ES | Pizarra de vaivén

Pizarra verde/blanca de Acero vitrificado sobre una estructura de aluminio anodizado en plata mate montada sobre suelo y pared. La pizarra se desliza y va guiada en el perfil por rodamientos de nylon. Ideales para colegios, universidades, anfiteatros,...

GB | 'Vaivén' board

Enamelled chalk board/white board mounted upon a supporting structure in silver anodised aluminium on stand or wall fixation. The surface slide is guided through a cable transmission. The ideal communication tool for large scale presentations, lecture theatres,...

FR | Tableau 'vaivén'

Tableau vert ou blanc émaillé monté sur une structure en aluminium anodisé couleur argent sur piétement ou fixation murale. La surface se déplace sur le profil par transmission par câbles. Pour une communication idéale dans les amphithéâtres, salles de congrès,...

DE | Pylonentafel

Emaillierte Tafelfläche, auf einer mattsilbernen, anodisierten Aluminiumstruktur, stehend und für Wandhalterung. Die Tafeln lassen sind mit einem Mechanismus von Seilzügen und Kunststoffrollen verbunden und lassen sich sehr leicht verschieben. Ideal für Schulen, Universitäten, grosse Auditorien etc.

IT | Lavagna a 'vaivén'

Lavagna smaltata (verde o bianca) montata su un supporto in alluminio silver fissato a terra o a muro; la superficie scorrevole è guidata da un sistema a cavi; ideale per comunicazioni su larga scala, presentazioni, teatri, palestre, ecc.

PO | Quadro de 'vaivén'

Quadro verde/branco de aço vitrificado sobre uma estrutura de alumínio anodizado na cor prata mate, montada no chão e à parede. O quadro desliza e é guiado num perfil por um sistema de transmissão por cabos e rolamentos de nylon.



	↑	↖	↗
720/2/G1	265	120 x 200	12
720/2/G2	265	120 x 250	12
720/2/G3	265	120 x 300	12
720/2/G4	265	120 x 400	12

* Consultar medidas especiales.
* Ask us for special sizes.

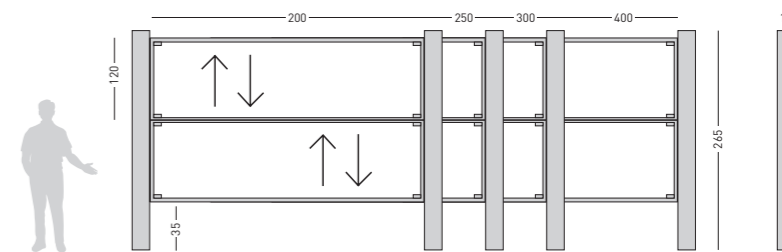

ES | Pizarra de guillotina

Conjunto de 2 pizarras verdes/blancas de acero vitrificado sobre una estructura de aluminio anodizado en plata mate montadas sobre suelo y pared. Las pizarras son independientes entre sí, guiadas por rodamientos de nylon.

GB | Sash board

2 enamelled chalk boards/white boards mounted upon a supporting structure in silver anodised aluminium on stand or wall fixation. Both writing surfaces slide vertically and are independent of each other. Guidance by nylon castors.

FR | Tableau guillotine

2 tableaux verts ou blancs émaillés montés sur une structure en aluminium anodisé couleur argent sur piétement ou fixation mural. Les deux surfaces se déplacent de façon indépendants et sont guidées par des poulies en nylon.

DE | Hin und her Bewegliche Tafeln

2 emaillierte Tafelflächen (weiß oder grün für Kreide) auf zwei Pfosten aus silber eloxiertem Aluminium montiert. Wand- oder Bodenbefestigung. Beide Tafeln sind voneinander unabhängig. Führung über Nylonrollen - Kettentrieb.

IT | Doppia lavagna congiunta smaltata

2 lavagne smaltate (verde o bianca) montate su un supporto in alluminio silver fissato a terra o a muro; entrambe le superfici scorrono verticalmente e sono indipendenti l'una dall'altra; la guida avviene mediante ruote in nylon.

PO | Quadro verde de guilhotina duplo

Conjunto de 2 quadros verdes/brancos em aço vitrificado sobre uma estrutura de alumínio anodizado na cor prata mate, montada no chão e à parede. O quadro desliza e é guiado num perfil por um sistema de transmissão por cabos e rolamentos de nylon.

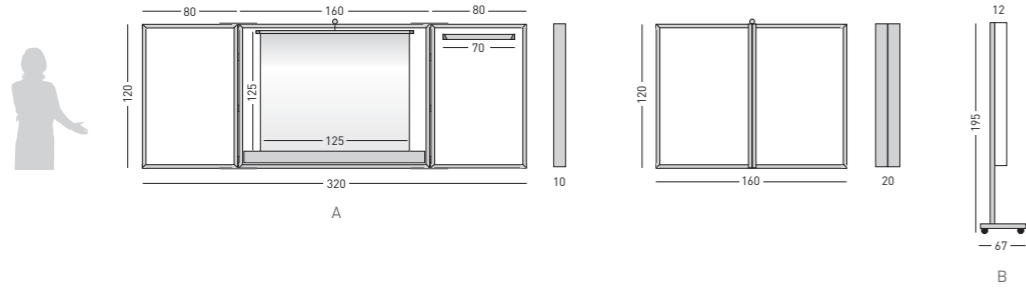

A	Screen	Depth
720/K	125 x 125	10

B	Height	Base Width
S/720/K	195	67

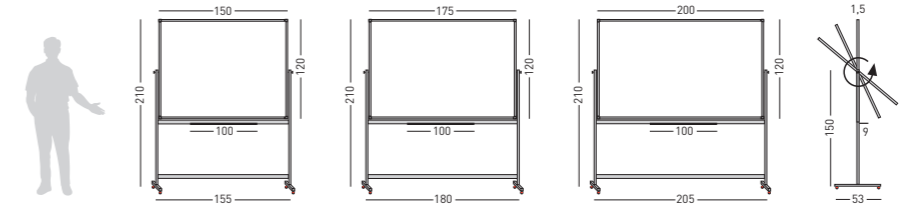

A	Height	Width	Depth	Base Width
720/X1	210	120 x 150	1,5	100
720/X2	210	120 x 175	1,5	100
720/X3	210	120 x 200	1,5	100

B	Height	Width	Depth	Base Width
725/X1	210	120 x 150	1,5	100
725/X2	210	120 x 175	1,5	100
725/X3	210	120 x 200	1,5	100

ES | Pizarra blanca "Cabinet"

Pizarra blanca enmarcada con perfil de aluminio lacado blanco. Superficie magnética de acero vitrificado rotulable en seco. Posee 5 superficies de escritura. Incluye soporte para 4 rotuladores, pinza portablocos y pantalla de proyección de 125 x 125 cm.

FR | Tableau/Armoire tryptique "Cabinet"

Tableau avec profil aluminium laqué blanc, superficie en acier émaillé et magnétique. 5 surfaces d'écriture, inclus un écran de projection (125 x 125 cm.) un porte feutre et pince porte bloc magnétique.

IT | Lavagna bianca "Cabinet"

Lavagna con cornice bianca in alluminio anodizzato. Superficie magnetica e smaltata adatta per la scrittura. 5 superfici di scrittura, incluso uno schermo di proiezione (125 x 125 cm.), un supporto verticale porta pennarelli e una pinza porta fogli.

ES | Pizarra blanca volteable

Pizarra blanca volteable doble cara enmarcada con perfil de aluminio anodizado en color plata mate y cantoneras redondeadas de plástico gris. Superficie de doble escritura rotulable en seco. Estructura volteable metálica móvil provista de 4 ruedas (2 de ellas con freno).

FR | Tableau blanc pivotant

Tableau blanc rotatif avec encadrement en aluminium anodisé argent aux coins arrondis en plastique gris. Monté sur piétement. Double surface d'écriture effaçable à sec. Support métallique mobile équipé de 4 roulettes (dont 2 à freins).

IT | Lavagna bianca smaltata ribaltabile

Lavagna ribaltabile con cornice in alluminio anodizzato naturale ed angoli grigi in plastica. Superficie bifacciale naturale ed angoli grigi in plastica. Superficie di doppia faccia para scrittura con pennarelli a secco. Supporto metallico spostabile con 4 ruote (di cui 2 frenanti). Porta pennarelli cm. 100 incluso.

GB | Whiteboard "Cabinet"

Whiteboard framed with whitecoloured anodised aluminium. Magnetic and enamelled surface suitable for writing. 5 separate writing surfaces. Vertical marker holder, pad holder and 125 x 125 cm. projector screen included.

DE | Wandtafel "Cabinet"

weiße Wandtafel mit weißem anodisiertem Aluminiumrahmen. Magnethaftende emailierte Schreiboberfläche. 5 aufgeteilte Oberflächen. Mit magnethaftenden Boardmarkern, einen Blockhalter und einer 125 x 125 cm ausziehbarer Projektionswand.

PO | Quadro branco "Cabinet"

Quadro branco com perfil em alumínio lacado branco. Superfície magnética em aço vitrificado para utilização de marcadores. Possui 5 superfícies de escrita. Inclui suporte vertical para marcadores, pinça para blocos de papel e tela de projecção com 125 x 125 cm.

GB | Revolving whiteboard

Revolving whiteboard equipped with silver anodised aluminium frame and grey plastic rounded corners. Double side surface is suitable for writing with dry wipe board markers. Metallic moveable support equipped with 4 castors (2 of them with brake).

DE | Drehtafel

Drehtafel mit anodisiertem Aluminium Rahmen silber eloxiert und abgerundeten grauen Kunststoffecken. Doppelseitige Schreibtafeloberfläche mit trocken abwischbaren Boardmarkern beschreibbar. Mobiles Fahrgestell mit 4 leichtgängigen Rollen (2 feststellbar).

PO | Quadro branco rotativo

Quadro branco rotativo de dupla face com perfil de alumínio anodizado na cor prata mate e cantos arredondados em plástico cinzento. Superfície de dupla face para escrita com marcadores. Estrutura rotativa metálica amovível com 4 rodas (2 delas com travão).

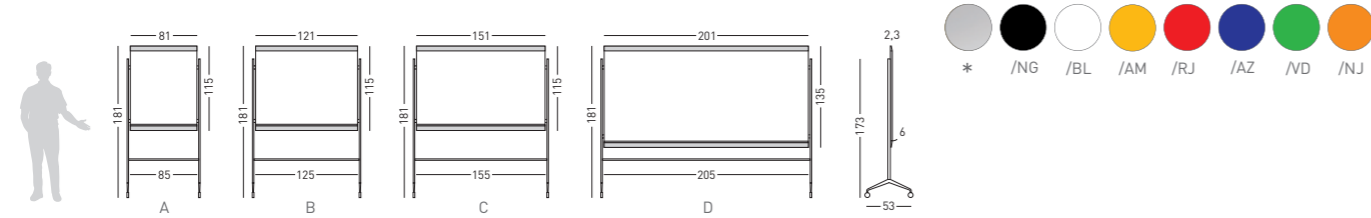

	*	↑	↙	↘	↔	⊠
A	Z/720/Y2	181	100 x 80	115 x 81	2,3	30
B	Z/720/Y3	181	100 x 120	115 x 121	2,3	30
C	Z/720/Y4	181	100 x 150	115 x 151	2,3	30
D	Z/720/Y6	181	120 x 200	135 x 201	2,3	30

ES | Pizarra "Zénit" con soporte Y2

Pizarra mural blanca Zénit sobre estructura Y2 de aluminio y pié de fundición con ruedas. Superficie magnética de acero vitrificado a 800° C con garantía de por vida. Rotulable en seco. Incluye cajetín reposarrotuladores.

FR | Tableau "Zénit" sur piétement Y2

Tableau mural blanc "Zenit" sur piétement "Y2" en aluminium et base en fonte avec roulette. Surface magnétique en acier émaillé cuit à 800° (garantie à vie) Pour feutre effaçables à sec, inclus auget porte feutre.

IT | Lavagna "Zénit" con struttura Y2

Lavagna murale Zenit bianco su struttura in alluminio Y2 ruote forno a piedi. Superficie vetrificata acciaio magnetico a 800 ° C, con una garanzia a vita. Evidenziatore su asciutto. Include porta evidenziatore e cancellino.

GB | "Zénit" whiteboard with Y2 support

Whiteboard "Zenit" with "Y2" structure, made of aluminium with iron cast base and castors. Magnetic and vitrified surface cooked at 800°C for dry erase. Life guaranteed. Included a marker-holder 30 cm.

DE | "Zénit" Stahlwandtafel Standbein Y2

Weißer Wandtafel mit einem Aluminiumrahmen und einem Standbein Y2 mit Rädern. Magnethaftende emaillierte Oberfläche, 800°C, mit lebenslanger Garantie. Trocken abwischbar. Inklusive Stiftablage.

PO | Quadro "Zénit" sobre estrutura Y2

Quadro branco Zénit, com perfil em alumínio anodizado na cor prata mate (tampas personalizáveis). Superfície magnética em aço vitrificado a 800° C com garantia vitalícia. Escrita com marcadores. Inclui suporte para marcadores e 2 ganchos para pendurar mapas.

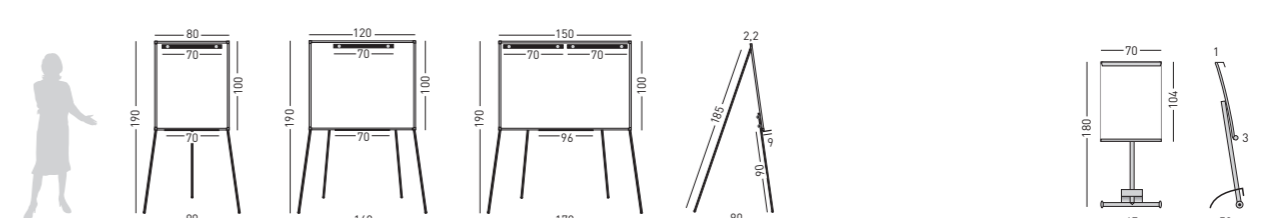
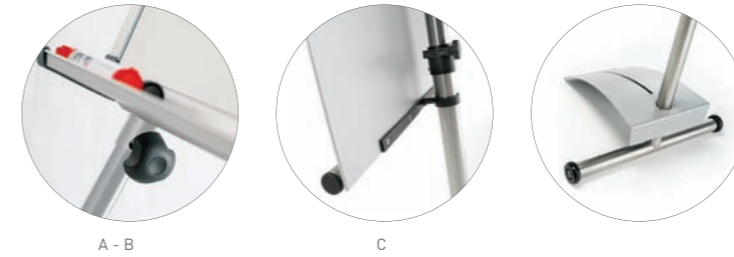

	↑	↙	↘	↔
A				
701/A	190	100 x 80	2,2	
702/A	190	100 x 150	2,2	
703/A	190	100 x 120	2,2	
B				
701/L	190	100 x 80	2,2	
702/L	190	100 x 150	2,2	
703/L	190	100 x 120	2,2	
C				
718/B	180	104 x 70	1	

ES | Pizarras de caballete de acero vitrificado

Pizarras de acero vitrificado enmarcadas con perfil de aluminio plata mate. Superficie magnética de acero vitrificado a 800° con garantía de por vida. 718 Design, fabricado en aluminio blanco. Sólo uso papel.

FR | Chevalet de conférence acier émaillé

Tableau en acier émaillé avec cadre en aluminium. Surface magnétique émaillé à 800° (garantie à vie). 718 Fabriqué en aluminium blanc. Utilisez uniquement du papier.

IT | Lavagna cavalletto acciaio vitrificato

Tavole in acciaio vitrificato incorniciato con l'alluminio argento opaco. Superficie vetrificata in acciaio magnetico a 800 °, con una garanzia a vita. 718 Design, in alluminio blanc. Utilizzare solo carta.

GB | Enamelled steel flipchart

Enamelled steel whiteboards with anodized aluminium frame [customizable]. Magnetic and vitrified surface cooked at 800°C for dry erase. Life guaranteed. 718 Design, made of white aluminum. Only use paper.

DE | Emailierte Flipchart

Emailierte Stahlwandtafel mit matt-silbernen Aluminiumrahmen. Magnethaftende, emaillierte Oberfläche, 800 °C, mit lebenslanger Garantie. 718 Design, aus weiss Aluminium gemacht. Verwenden Sie nur Papier.

PO | Quadro de cavelete em Aço Vitrificado

Quadros em Aço Vitrificado, com perfil em alumínio na cor prata mate. Superfície magnética em Aço Vitrificado a 800° C, com garantia vitalícia. 718 Design, feito de alumínio blanc. Só use papel.

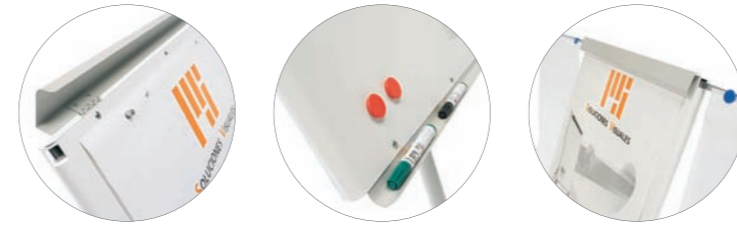

32



33

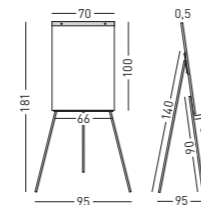
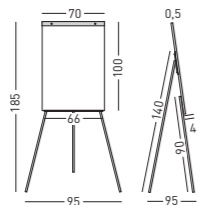

A
711/N 185 100 x 70 0,5

B
704/N 181 100 x 70 0,5

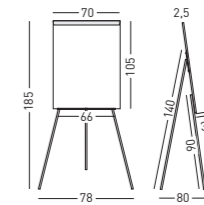
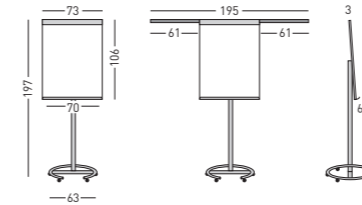

A
709/N 197 106 x 73 3

B
712/N 185 105 x 70 2,5

ES | Pizarra de caballete

Colección de pizarras de caballete de alta calidad. Ref. 711/N apta para escritura sobre block de papel, mientras que la 704/N es laminada y permite tanto escritura y borrado en seco como adaptarles blocks de papel.

FR | Chevalet de conférence

Gamme de chevalets de bonne qualité. Réf 711/N est pour les blocs papier, alors que la réf. 704/N avec surface stratifié pour écriture avec feutre effaçable à sec et/ou des blocs de papier.

IT | Lavagna su cavalletto di alta qualità

Ref. 711/N adatta per scrittura su blocco di carta, mentre per la 704/N è laminata e permette sia la scrittura e cancellaturo, che adattabile con il blocco di carta.

ES | Pizarra de conferencias con ruedas

Colección de pizarras de caballete de gran robustez. La ref. 709/N de superficie lacada y magnética incorpora soporte móvil con ruedas y es graduable en altura, mientras que la ref. 712/N también magnética y lacada posee la estructura plegable.

FR | Chevalet de conférence mobile

Gamme de chevalets très robustes. Le Réf. 709/N est avec une surface laquée et magnétique, mobile, support sur roulettes est réglable en hauteur, tandis que la réf. 712/N est également maquée et magnétique et avec un structure pliable.

IT | Lavagna da conferenza con ruote

Collezione di lavagne da terra di grande robustezza. Il Ref. 709/N con superficie laccata e magnetica include un supporto da terra mobile su ruote e regolabile in altezza, mentre il Ref. 712/N e' anche lei magnetica e laccata, ma con la struttura pieghevole.

GB | Flipchart easel

Range of high quality flipchart. Ref. 711/N is suitable for paper writing while the 704/N is laminated and allow both writing on board and paper.

DE | Flipcharts

Auswahl von Flipcharts höchster Qualität. Das Model 711/N ist geeignet für die Benutzung mit Papierblöcken, während das Model 704/N sowohl für die Trockenbeschriftung, als auch für Papierblöcke geeignet ist.

PO | Quadro de cavalete

Coleção de quadros de cavalete de alta qualidade. Refª 711/N permite a escrita no bloco de papel, enquanto a Refª 704/M é laminada e permite a escrita tanto na sua superfície como se pode adaptar um bloco de papel.

GB | Mobile flipchart

Range of strong flipchart. Ref. 709/N with a magnetic lacquered surface and with a movable base and high adjustable while the 712/N also magnetic and lacquered and a foldable base.

DE | Mobiles Flipchart

Auswahl von sehr robusten Flipcharts. Das Model 709/N mit einer lackierten, magnetisierenden Oberfläche ist auf einem fahrbarem, höhenverstellbarem Gestell montiert. Das ebenfalls lackierte und magnetisierende Model 712/N ist klappbar.

PO | Quadro com suporte de rodas

Coleção de quadros de cavalete de grande robustez. A Refª 709/N tem a superfície laccada e magnetica e tem um suporte com rodas ajustável em altura, enquanto a Refª 712/N também é laccada magnetica e possui um cavalete em forma de tripé.



A	↑	↔	↔ max
Y2/80/R	173	53	80
Y2/120/R	173	53	120
Y2/150/R	173	53	150
Y2/175/R	173	53	175
Y2/200/R	173	53	200

B	↑	↔	↔ max
Y2/80/N	173	53	80
Y2/120/N	173	53	120
Y2/150/N	173	53	150
Y2/175/N	173	53	175
Y2/200/N	173	53	200



	↑	↔	↔ max
770/1	174	53	120 x 200

ES | Soporte "Y2" y "T"

"Y2" Juego de soportes, fabricados en perfil de aluminio y pié de fundición. Incorpora ruedas con freno o niveladores. "T" Juego de soportes metálicos, para adaptar pizarras, tableros, etc. Uso aconsejable hasta 2 metros de largo.

FR | Piétements "Y2" et "T"

"Y2" Jeu de 2 piétements métalliques en aluminium et fonte. Livré avec roulettes munies de freins. "T" Piétement avec 4 roulettes (dont 2 avec freins). Taille recommande de tableau et vitrines 2m max.

IT | Supporti "Y2" e "T"

"Y2" Serie di supporti, fabbricati in alluminio e base in ghisa. Include ruote con freni. Adattabile a tutta la gamma di lavagne, pannelli e bacheche. "T" Supporto con 4 ruote (di cui 2 frenanti). Raccomandato per lunghezze fino ai 2 metri.

GB | Supports "Y2" & "T"

"Y2" Set of 2 aluminium and cast-iron supports with castors or jacks for whiteboard. Suitable for all showcases, boards and panels... "T" support with 4 castors (2 of them with brake). Recommended for lengths of up to 2 meters.

DE | Tafelstativ "Y2" und "T"

"Y2" Höhenverstellbares Tafelstativ aus Aluminium. Rollenstativ mit Bremsen. Empfehlenswert für jegliche Art von Tafeln, Vitrinen und Wandtafeln. "T" Stativ mit 4 Rollen (2 davon sind abbremsbar). Empfehlenswert für Tafeln,... bis zum 2 Meter lang.

PO | Suportes "Y2" e "T"

"Y2" Conjunto de suportes, fabricados em perfil de alumínio. Possui rodas com travão ou niveladores. "T" Conjunto de suportes metálicos para adaptar a quadros, quadros de anúncios, etc. Utilização aconselhável até 2 metros de largura.



A	↑	↔	↔ max
770/2	174	53	120 x 200

B	↑	↔	↔ max
770/5	160	90	100 x 120

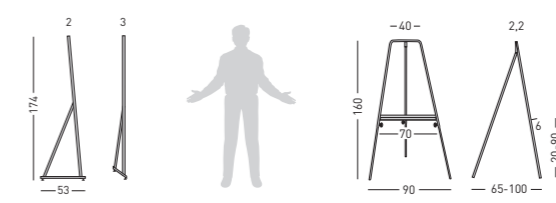

ES | Soporte forma "Delta" y trípode

Soportes metálicos pintados en pintura epoxi gris. El modelo 770/2 en forma Delta posee 4 niveladores y permite una dimensión del tablero máxima de 2 m. y el 770/5 es graduable en altura.

FR | Piétement "Delta" et chevalet

Piétements métalliques avec peinture époxy grise. Le modèle 770/2 en forme de Delta à 4 niveleurs et pour une dimension de tableau maxi. recommandée de 2 m. La Réf. 770/5 est réglable en hauteur.

IT | Supporto "Delta" e tripiede

Supporti in metallo verniciato grigio epossidica. Il modello 770/2, come Delta ha 4 livelli e consente una dimensione massima di bordo di 2 m. e 770/5 è regolabile in altezza.

GB | Support "Delta" & tripod

Metallic stand with grey epoxy paint. Ref. 770/2 Delta shape has 4 levellers for [recommended] board sizes max. 2 meters. Ref 770/5 is height adjustable.

DE | "Delta" Zweibeinstativ/Höhenverstellbares

Standbein aus Metall, in epoxi-grau gefärbt. Das Modell 770/2, Delta-Form, ist vierfach nivellierend und erreicht samt Tafel eine Gesamthöhe von 2 Meter. Das Modell 770/5 ist höhenverstellbar.

PO | Suporte "Delta" e tripé ajustável

Suportes metálicos pintados na cor cinzenta. O modelo 770/2, em forma de "Delta", possui 4 niveladores e permite adaptar quadros até 2 m. O modelo 770/5 é ajustável em altura.



A
RAIL
RP/30

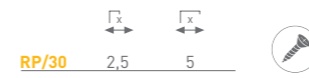

B
RAIL
L

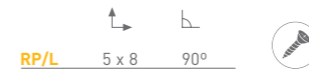
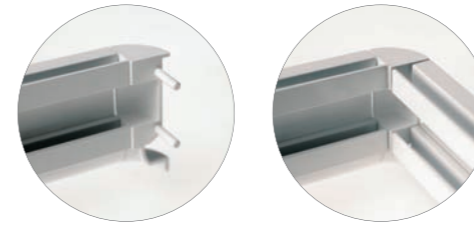

	↔	↑
RP/000	-	8
RP/100	100	8
RP/200	200	8
RP/300	300	8

ES | Rail plan

Rail plan es el sistema que mediante un perfil de aluminio lacado blanco, fijado a la pared, permite colgar en sus dos carriles, pizarras, tableros, etc... desplazarlos longitudinalmente y hacer posible cualquier tipo de presentación, etc...

FR | Rail plan

Système de rail en aluminium (blanc) en fixation murale pour superposer et faire coulisser des tableaux sur deux hauteurs de rail, idéal pour les présentations dans le bureau ou en salles de cours. Les documents seront soutenus par pression sous le rail.

IT | Rail plan

Sistema di guida in alluminio (bianco) e fissaggio a muro per che permette di appendere ogni tipo di bacheca e di muoverla orizzontalmente, per facilitare le presentazioni e le esposizioni. Sotto alla guida più bassa trovare dei cuscinetti a sfera adatto per carte.

ES | Anclajes y conector "L"

El anclaje RP/30 permite adaptar la gama de tableros hasta una medida máxima de 175 cm. El rodamiento inferior abatible, permite en una misma pieza, la opción de carril inferior o superior. El conector RP/L se utiliza en las esquinas, para unir a 90° los dos railes.

FR | Ancrages et connecteur "L"

Les fixations RP/30 permettent d'adapter toute la gamme de tableau jusqu'à 175 cm de base. La roulette pliante en partie basse permet de positionner le tableau sur les deux hauteurs de rail pour les faire coulisser. La connexion pour les angles avec réf. RP/L.

IT | Binario connettore ad "L"

Fissaggio RP/30 permette di adattare di adattare tutta la gamma delle bacheche ad una lunghezza massima di 175 cm. La rotella pieghevole nella parte inferiore permette di posizionare le bacheche l'una sotto l'altra. Il fissaggio RP/L unire un angolo di 90°.

GB | Rail plan

Rail Plan's lacquered aluminium profile fixed on a wall allows you to hang up any kind of boards, etc. and move them horizontally to help you with your presentations, expositions, etc. Below the lower rail, you will find bearings suitable for hanging note pads, etc.

DE | Rail plan

Rail Plan ist ein 2-Kanal-Wandschienensystem aus weiß lackiertem Aluminiumrahmen. Alle Wandsysteme können in dieses System eingehängt werden. Durch die leichte Handhabung ermöglicht es eine einfache und schnelle Präsentation in ihrem Büro.

PO | Rail plan

Rail Plan é um sistema que através de um perfil em alumínio lacado branco, fixado à parede, permite pendurar nos seus carris, quadros, quadros de anúncios, etc... deslocando-os, tornando possível qualquer tipo de apresentação, etc...

GB | Anchorages & "L" connector

Anchorage RP/30 allows you to adapt boards of a maximum recommended length of 175 cm. The inferior folding tread enables to slide the different panels one under the other. The whole kit is supplied. Anchorage RP/L is used in corners to join two rails in a 90° angle.

DE | Wandschienenset verbinder "L"

Die Verankerung RP/30 ermöglicht die Anbringung jeglicher Art von Tafeln, ob Wandtafel, Stofftafel etc. bis zu einer empfohlenen Breite von 175 cm. Das aus einem Guß bestehende System, ermöglicht die variable Benutzung der oberen Schiene oder der unteren Rolle.

PO | Encaixes e ligação em "L"

O suporte RP/30 permite adaptar a gama de quadros até à medida máxima de 175 cm. O rolamento inferior, permite numa mesma peça, a opção de carril inferior ou superior. A ligação RP/L é utilizada em esquinas, para unir em forma de "L" a 90° os perfis.



pg. 22

pg. 12

pg. 92

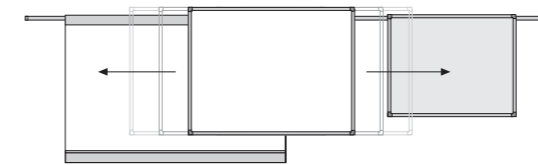

780 SLIDE

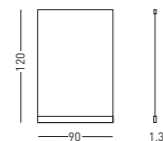
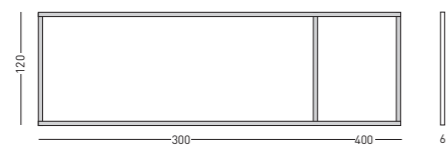
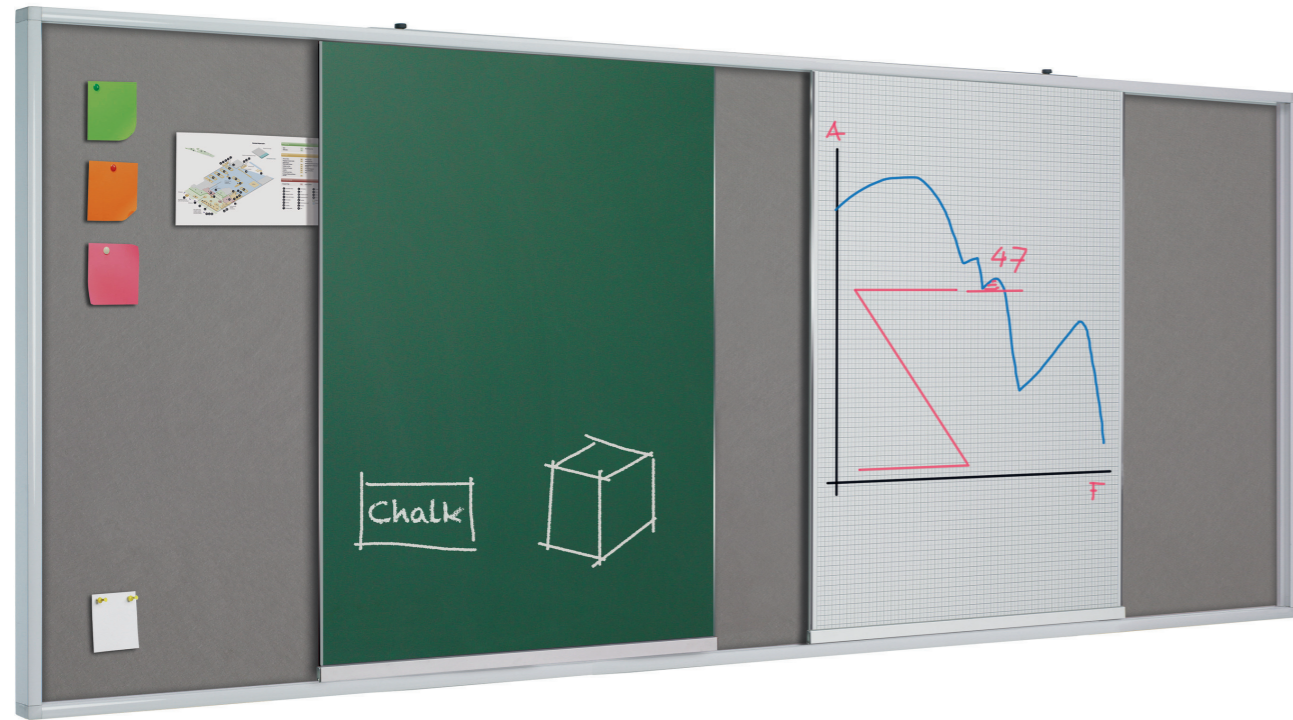

	120 x 300	6
780/P3	120 x 300	6
780/T3	120 x 300	6
780/PB	120 x 90	6
7800/PV	120 x 90	6
7800/PC2	120 x 90	6
7800/PC5	120 x 90	6

ES | Sliding frame

Sistema multifuncional de presentación modular, configurable según cada necesidad. Panel mural en versión tablero tapizado o pizarra verde, y paneles deslizantes delanteros en diversos acabados de pizarra verde lisa, o cuadrícula verde de 2x2 y 5x5.

FR | Sliding frame

Système multifonctionnel d'affichage modulaire, configurable pour chaque besoin. Panneau mural version liège + tissu ou tableau vert, les panneaux frontaux et coulissants en différentes finitions tableau vert lisse ou avec quadrillage sur fond vert de 2x2 et 5x5.

IT | Sliding frame

Sistema multifunzionale per la presentazione modulare, configurabile a secondo della necessità. Pannello murale in versione beacheca tappezzata o lavagna verde e sistema di pannelli scorrevoli a lavagna verde liscia o a quadretti verdi 2x2 o 5x5.

GB | Sliding frame

Multifunctional and modular presentation system, for any kind of use. Wall panel made of cork panel board, white or green board and the front movable panels with different finishes as grooved 2x2 or 5x5, plain, chalk board.

DE | Multifunktionales Präsentationssystem

Multifunktionales Präsentationssystem, nach Bedarf individuell zu Gestalten. Die Wandplatte als bespannte Platte oder grüne Tafel, Die beweglichen Seitenteile in verschiedenen Ausführungen und Verarbeitungen, grüne Tafel, grüne, glatte Tafel 2x2 oder 5x5

PO | Sliding frame

Sistema multifuncional de apresentação modular, configurável de acordo com cada necessidade. Painel de parede em versão quadro forrado ou quadro verde, e painéis dianteiros deslizantes em diversos acabamentos de quadro branco liso, verde liso ou quadriculado de 2x2 e 5x5.

A
frame
AV



	120 x 300	6
780/P3	120 x 300	6

B
frame
felt



	120 x 300	6
780/T3	120 x 300	6

C
panel

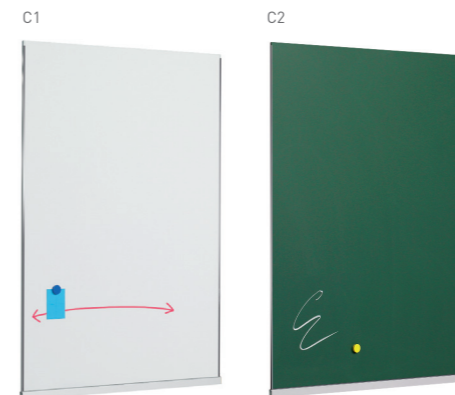

	120 x 90	1,3
C1 7800/PB	120 x 90	1,3
C2 7800/PV	120 x 90	1,3

D
panel

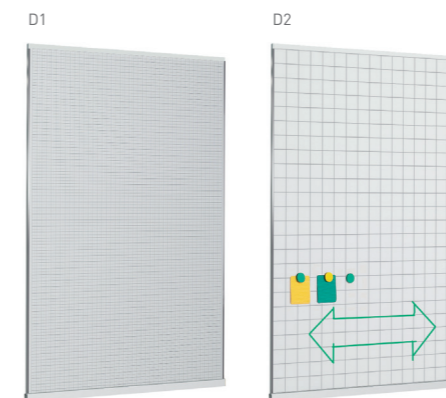

	120 x 90	1,3
D1 7800/PC2	120 x 90	1,3
D2 7800/PC5	120 x 90	1,3

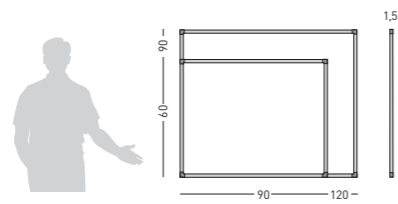
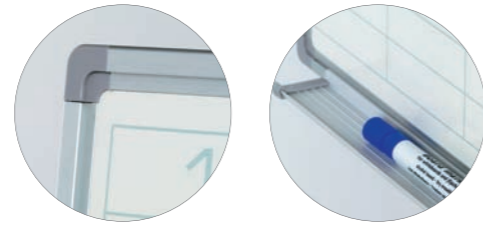

	60 x 90	1,5	30
1000/S1	60 x 90	1,5	30
1000/S2	90 x 120	1,5	30

ES | **Planning magnético**

Planning mural blanco serigrafiado, rotulable con rotuladores de borrado en seco, enmarcado con perfil de aluminio anodizado en color plata mate y cantoneras redondeadas grises. Incluye un cajetín reposarrotuladores de 30 cm. La superficie está serigrafiada en color gris claro y permite adaptar material magnético.

GB | **Magnetic planner**

Magnetic planner equipped with silver anodised aluminum frame and grey plastic rounded corners. Enamelled surface is suitable for writing on with dry wipe board makers. A 30 cm. pen tray included.

FR | **Planning magnétique**

Planning magnétique quadrillé avec encadrement en aluminium anodisé couleur argent et coins arrondis en plastic gris. Surface en acier émaillé blanc effaçable à sec. Livré avec auget porte marqueurs de 30 cm.

DE | **Magnetische Planungstafel**

Lackierte Wandtafel "Planning" in weiss, mit trocken abwischbaren Markern beschriftbar, mit anodisiertem Aluminiumrahmen, silbereloxiert, mit abgerundeten Kunststoffecken. Stiftablage von 30cm. Die Oberfläche ist in hellgrau lackiert und magnethaftend.

IT | **Planning giornaliero magnetico**

Planning magnetico con cornice in alluminio anodizzato ed angoli grigi in plastica. Superficie smaltata disponibile per scrittura con pennarelli a secco. Incluso porta penne da 30 cm.

PO | **Planning magnético**

Planning de parede branco serigrafado, com superfície para escrita com marcadores de limpeza a seco, perfil em alumínio anodizado na cor prata mate e cantos arredondados cinzentos. Inclui suporte para marcadores de 30 cm.

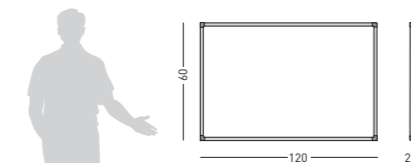
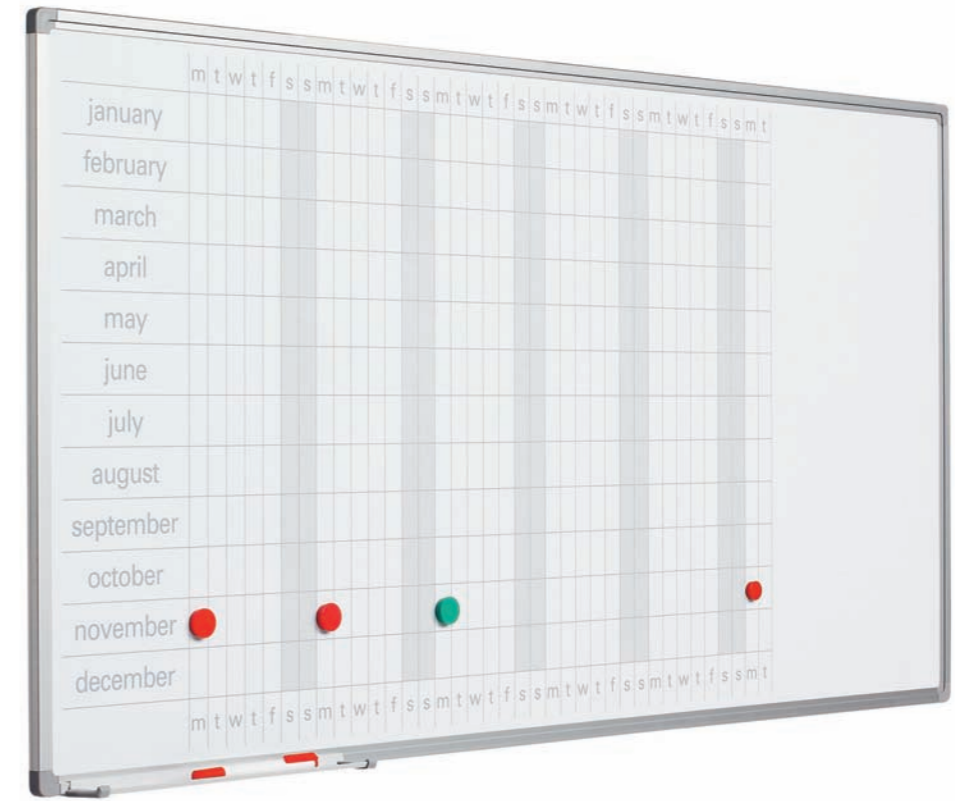
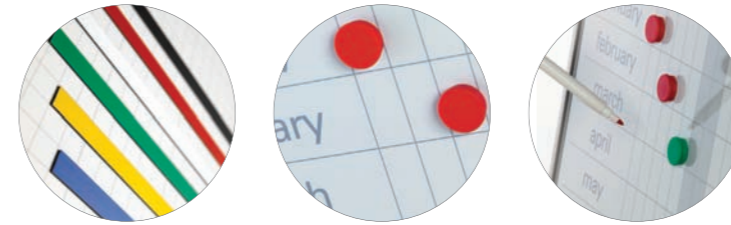

	60 x 120	1,5	30
1000/A1	60 x 120	1,5	30
* 1000/A10	60 x 120	1,5	30

* Incluye 12 tiras magnéticas para meses.
* 12 units of magnetic stripes one for each month.

ES | **Planning magnético**

Planning mural blanco serigrafiado, rotulable con rotuladores de borrado en seco, enmarcado con perfil de aluminio anodizado en color plata mate y cantoneras redondeadas grises. Incluye un cajetín reposarrotuladores de 30 cm. La superficie está serigrafiada en color gris claro y permite adaptar material magnético.

GB | **Magnetic planner**

Magnetic planner equipped with silver anodised aluminum frame and grey plastic rounded corners. Enamelled surface is suitable for writing on with dry wipe board makers. A 30 cm. pen tray included.

FR | **Planning magnétique**

Planning magnétique quadrillé avec encadrement en aluminium anodisé couleur argent et coins arrondis en plastic gris. Surface en acier émaillé blanc effaçable à sec. Livré avec auget porte marqueurs de 30 cm.

DE | **Magnetische Planungstafel**

Lackierte Wandtafel "Planning" in weiss, mit trocken abwischbaren Markern beschriftbar, mit anodisiertem Aluminiumrahmen, silbereloxiert, mit abgerundeten Kunststoffecken. Stiftablage von 30cm. Die Oberfläche ist in hellgrau lackiert und magnethaftend.

IT | **Planning giornaliero magnetico**

Planning magnetico con cornice in alluminio anodizzato ed angoli grigi in plastica. Superficie smaltata disponibile per scrittura con pennarelli a secco. Incluso porta penne da 30 cm.

PO | **Planning magnético**

Planning de parede branco serigrafado, com superfície para escrita com marcadores de limpeza a seco, perfil em alumínio anodizado na cor prata mate e cantos arredondados cinzentos. Inclui suporte para marcadores de 30 cm.

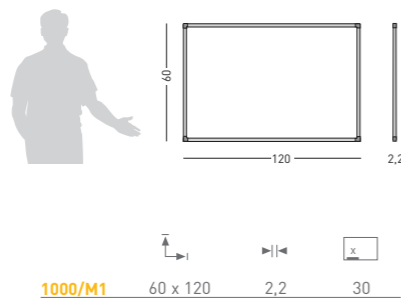
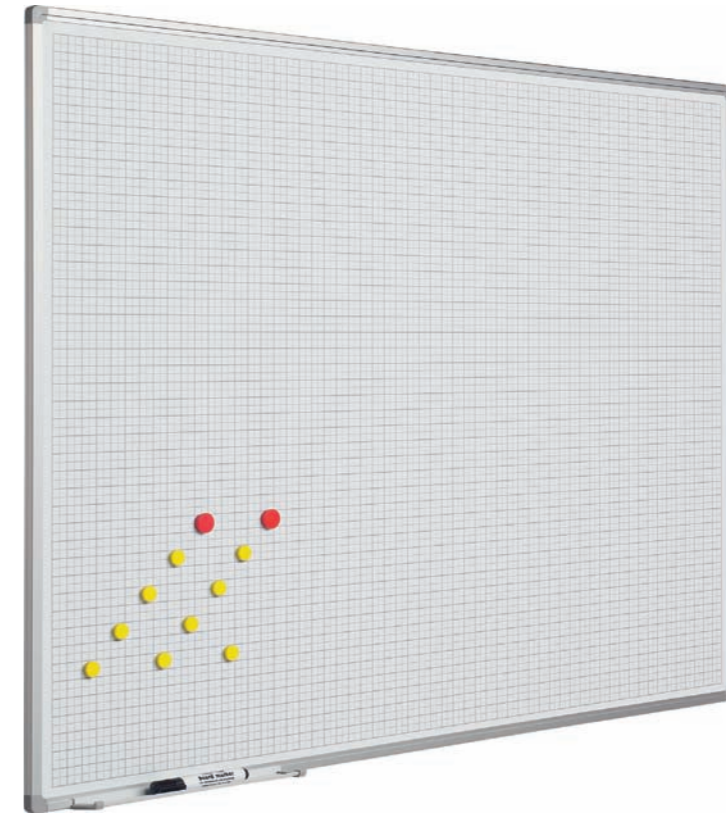
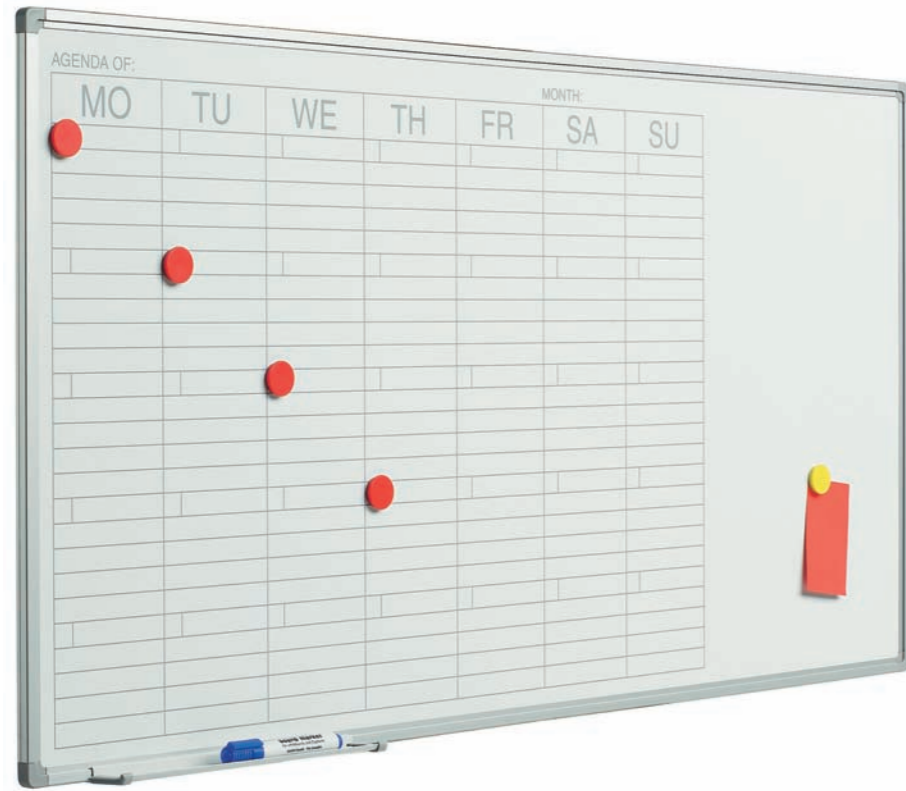
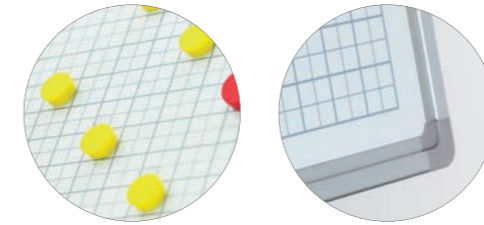

	↑	→	⊗
720/C1	45 x 60	2,2	30
720/C2	60 x 90	2,2	30
720/C3	90 x 120	2,2	30
720/C4	120 x 180	2,2	30

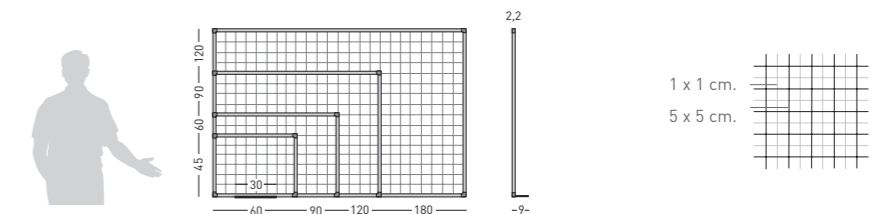

ES | Planning magnético
Planning mural blanco serigrafiado, rotulable con rotuladores de borrado en seco, enmarcado con perfil de aluminio anodizado en color plata mate y cantoneras redondeadas grises. Incluye un cajetín reposarrotuladores de 30 cm. La superficie está serigrafiada en color gris claro y permite adaptar material magnético.

FR | Planning magnétique
Planning magnétique quadrillé avec encadrement en aluminium anodisé couleur argent et coins arrondis en plastique gris. Surface en acier émaillé blanc effaçable à sec. Livré avec auget porte marqueurs de 30 cm.

IT | Planning giornaliero magnetico
Planning magnetico con cornice in alluminio anodizzato ed angoli grigi in plastica. Superficie smaltata disponibile per scrittura con pennarelli a secco. Incluso porta penne da 30 cm.

ES | Pizarra mural cuadriculada
Pizarra mural blanca cuadriculada con perfil de aluminio anodizado en color plata mate y cantoneras redondeadas de plástico gris. Superficie rotulable en seco. Incluye cajetín reposarrotuladores de 30 cm.

FR | Tableau blanc quadrillé
Tableau blanc quadrillé avec encadrement en aluminium anodisé couleur argent aux coins arrondis en plastique gris. Surface effaçable à sec. Livré avec un auget porte marqueurs de 30 cm.

IT | Lavagna a quadretti smaltata
Lavagna a quadretti con cornice in alluminio anodizzato naturale ed angoli grigi in plastica. Superficie scrivibile con pennarelli a secco. Porta pennarelli da 30 cm. Incluso.

GB | Magnetic planner
Magnetic planner equipped with silver anodised aluminium frame and grey plastic rounded corners. Enamelled surface is suitable for writing on with dry wipe board makers. A 30 cm. pen tray included.

DE | Magnetische Planungstafel
Lackierte Wandtafel "Planning" in weiss, mit trocken abwischbaren Markern beschriftbar, mit anodisiertem Aluminiumrahmen, silbereloxiert, mit abgerundeten Kunststoffecken. Stiftablage von 30cm. Die Oberfläche ist in hellgrau lackiert und magnethaftend.

PO | Planning magnético
Planning de parede branco serigrafiado, com superfície para escrita com marcadores de limpeza a seco, perfil em alumínio anodizado na cor prata mate e cantos arredondados cinzentos. Inclui suporte para marcadores de 30 cm.

GB | Gridded whiteboards
Gridded Whiteboard equipped with silver anodised aluminium frame and grey plastic rounded corners. Surface is suitable for writing with dry wipe board markers. A 30 cm. pen tray included.

DE | Rastertafel
Rastertafel mit anodisiertem Aluminiumrahmen, silber eloxiert und abgerundeten grauen Kunststoffecken. Schreibtafeloberfläche mit trocken abwischbaren Boardmarkern beschreibbar. Lieferung inkl.: Stiftablage 30 cm. lang.

PO | Quadro quadriculado
Quadro de parede branco quadriculado com perfil de alumínio anodizado na cor prata mate e cantos arredondados em plástico cinzento. Superfície branca para escrita com marcadores. Inclui suporte para marcadores com 30 cm.

LEAN SOLUTIONS



44

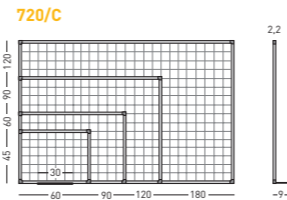
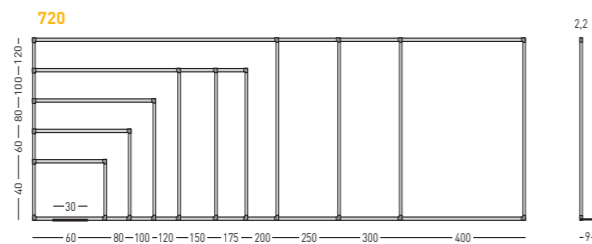
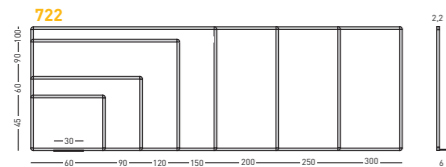

ES | Lean Solutions

Diversas pizarras murales o sobre soportes fijos o con ruedas, para diseñar diversidad de "Lean solutions" para implementar en fábricas, almacenes, oficinas, procesos... La variedad de accesorios magnéticos y adhesivos permiten encontrar la solución ideal a cada necesidad.

GB | Lean Solutions

Range of wall or on stand (fix or on castor) board made for several kind of uses and design of "lean solutions" in factories, offices, schools... Customise and work you own with adhesives, magnets.

FR | Lean Solutions

Divers tableaux ou sur support muraux fixes ou mobiles, pour créer le "Lean Solutions" et mettre en place dans les usines, les entrepôts, les bureaux, les processus propres à chaque pôle d'activité. Plusieurs accessoires magnétiques et adhésifs permettent de trouver la solution idéale pour tous les besoins.

DE | Verschiedene Tafel, fix oder beweglich

Verschiedene Tafeln auf festen oder beweglichen Trägern, um unterschiedliche Möglichkeiten des "lean solution" anzuwenden. Einsatzmöglichkeiten in Fabriken, Lagerhallen, Büros, etc... Das reichhaltige Zubehör bietet Lösungen für alle Bedürfnisse.

IT | Lean Solutions

Lavagna a muro o sopra supporti fissi o con ruote, per disegnare diversamente di "Lean Solutions" per migliorare fabbriche, magazzini, uffici. La varietà degli accessori magnetici e adesivi permette di raggiungere la soluzione ideale a qualsiasi necessità.

PO | Lean Solutions

Diversos quadros de parede ou sobre suportes fixos ou com rodas, para desenhar. Grande diversidade de quadros "Lean Solutions" para aplicar em fábricas, armazéns, escritórios... A variedade de acessórios magnéticos e adesivos permitem a solução ideal para cada necessidade.

A options

SIZE	720	722	720/C	720/D	720/T
60 x 80	720/1				
60 x 90		722/2	720/C2		
80 x 100	720/2				
90 x 120		722/3	720/C3	720/D1	
100 x 120	720/3				
100 x 150	720/4	722/5			
100 x 175	720/5				
120 x 180			720/C4	720/D2	
100 x 200		722/6			
120 x 200	720/6				
90 x 240					720/T1
120 x 250	720/7				
120 x 300	720/8				
120 x 400	720/9				720/T2

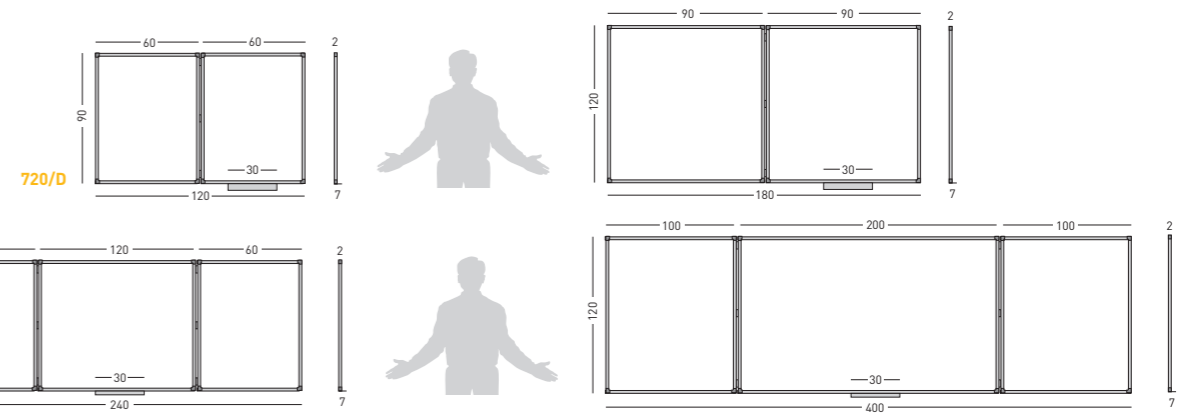

45

B examples



LEAN SOLUTIONS

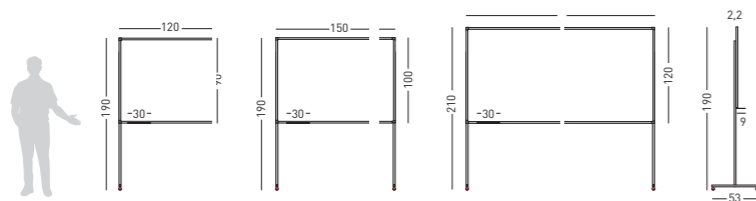

720/T

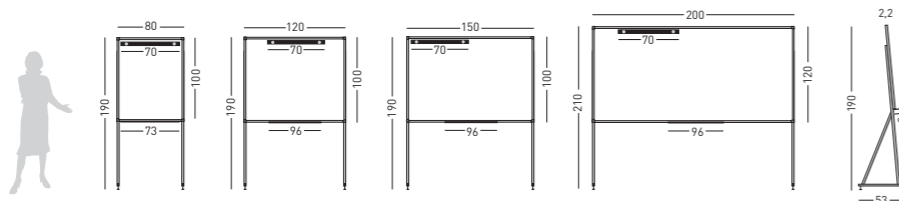

720/D

es | Lean Solutions

Pizarras murales o sobre soportes fijos o con ruedas, para diseñar diversidad de "Lean solutions" para implementar en fábricas, almacenes, oficinas, procesos... La variedad de accesorios magnéticos y adhesivos permiten encontrar la solución ideal a cada necesidad.

68 | Lean Solutions

Range of wall or on stand (fix or on castor) board made for several kind of uses and design of "lean solutions" in factories, offices, schools... Customize and work you own with adhesives, magnets.

FR | Lean Solutions

Divers tableaux ou sur support muraux fixes ou mobiles, pour créer le "Lean Solutions" et mettre en place dans les usines, les entrepôts, les bureaux, les processus propres à chaque pôle d'activité. Plusieurs accessoires magnétiques et adhésifs permettent de trouver la solution idéale pour tous les besoins.

DE | Verschiedene Tafel, fix oder beweglich

Verschiedene Tafeln auf festen oder beweglichen Trägern, um unterschiedliche Möglichkeiten des "lean solution" anzuwenden. Einsatzmöglichkeiten in Fabriken, Lagerhallen, Büros, etc... Das reichhaltige Zubehör bietet Lösungen für alle Bedürfnisse.

IT | Lean Solutions

Lavagna a muro o sopra supporti fissi o con ruote, per disegnare diversamente di "Lean Solutions" per migliorare fabbriche, magazzini, uffici. La varietà degli accessori magnetici e adesivi permette di raggiungere la soluzione ideale a qualsiasi necessità.

PO | Lean Solutions

Diversos quadros de parede ou sobre suportes fixos ou com rodas, para desenhar. Grande diversidade de quadros "Lean Solutions" para aplicar em fábricas, armazéns, escritórios... A variedade de acessórios magnéticos e adesivos permitem a solução ideal para cada necessidade.

A
options

SIZE	AV 770/1	AVC 770/1	AV 770/2	AVC 770/2	750/AVP
80 x 100	705/A		707/A		
90 x 120		720/C3/T		720/C3/D	
100 x 120	706/A		708/A		
100 x 150	713/A		715/A		750/AVP
100 x 175	720/5				
120 x 180		720/C4/T		720/C4/D	
100 x 200					
120 x 200	714/A		716/A		

B
exemples



X
aces



9002 - 9003 - 9004



9010



9011



9012

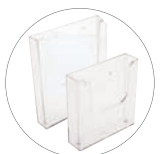

A4/M - A5/M



PF/A4/M - PF/A5/M



7005



7009



7019



7008

720/F
720/B

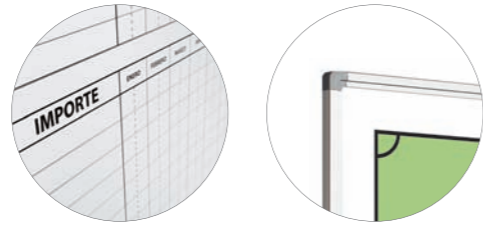

A
personalize

48

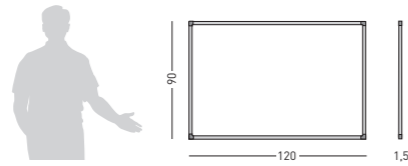
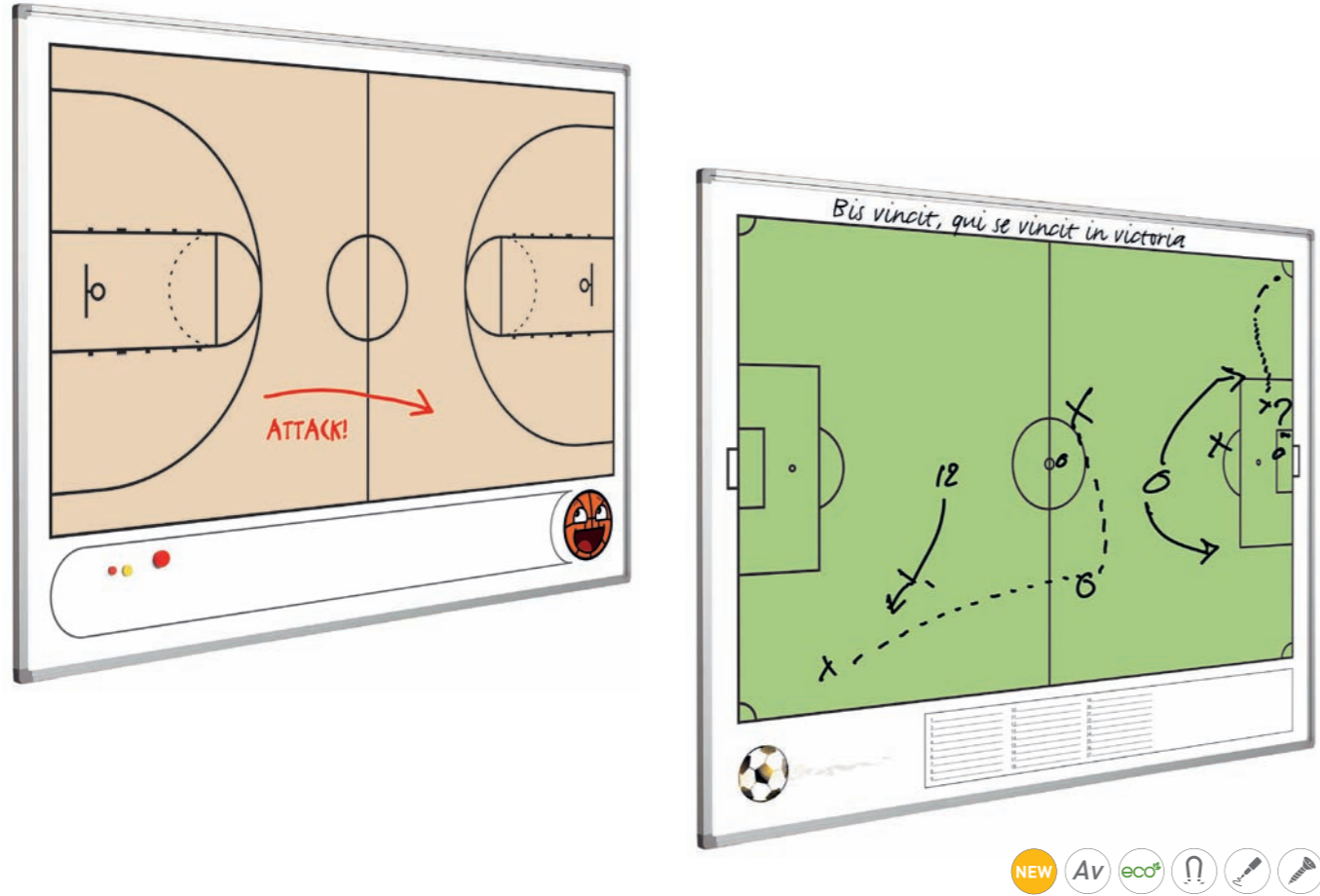

	↑	→	□
720/F	90 x 120	1,5	30
720/B	90 x 120	1,5	30

ES | Pizarras fútbol/básquet

Pizarra mural blanca enmarcada con perfil de aluminio anodizado en color plata mate y cantoneras redondeadas de plástico gris. Superficie magnética de acero vitrificado a 800° C con garantía de por vida. Rotulable en seco. Serigrafía campo de fútbol/básquet. Incluye cajetín reposarrotuladores de 30 cm.

GB | Football/Basketball whiteboard

whiteboard with silver anodised aluminium frame and plastic corner. 800° C "Life-time guarantee" Enamelled surface suitable for writing with dry makers. Serigraphy with basketball or football field and with a 30 cm pen tray.

FR | Tableaux Football et Basket

Tableau mural blanc avec profil en aluminium anodisé couleur argent mat et coins gris en plastic arrondis. Surface en acier emmaillé et magnétique cuite à 800° C garantie à vie pour feutres effaçables à sec. Sérigraphie football / basket-ball. Auget inclus de 30 cm.

DE | Weisse Wandtafel

Weisse Wandtafel mit anodisiertem Aluminiumrahmen, silbereloxiert, mit abgerundeten Kunststoffecken. Magnethaftend, gehärtet bei 800- Celsius, geeignet für Trocknenbeschriftung mit allen gängigen Markern, unbegrenzte Garantie, Aufdruck Fussball- oder Basketballfeld, Stiftablage von 30cm.

IT | Lavagna Football è Basket

Lavagna a muro bianca contornata da profilo in alluminio anodizzato color argento opaco e raccordi angolari arrotondati in plastica grigia. Superficie magnetica in acciaio vetrificato a 800°C con garanzia a vita. Etichetta asciutta, serigrafia con campo di calcio/pallacanestro.

PO | Quadro branco Football è Basket

Quadro de parede com perfil em alumínio na cor prata mate e cantos redondos em plástico cinzento. Superfície magnética em aço vitrificado a 800° C com garantia vitalícia. Superfície para utilização de marcadores de limpeza a seco. Serigrafia de campo de futebol/basquete. Inclui suporte de 30 cm.

49



X
acces



9002 - 9003 - 9004



9010



9011



7005



7009



7015

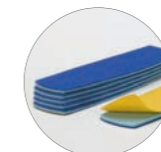

7015/1

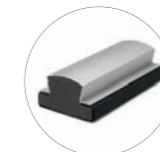

7012

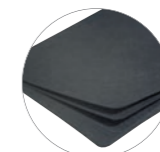

7006/1

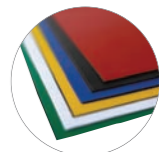

9000



A
45 x 60

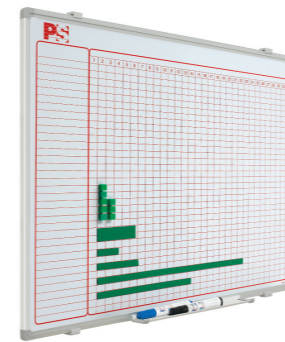

1000/1

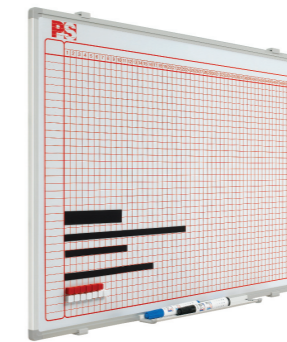

1000/2



1000/3

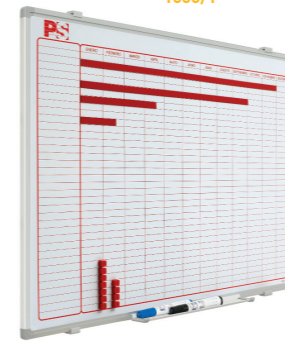

1000/4

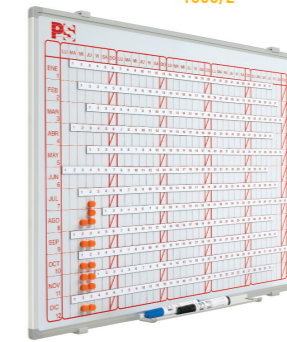

1000/5



1000/7

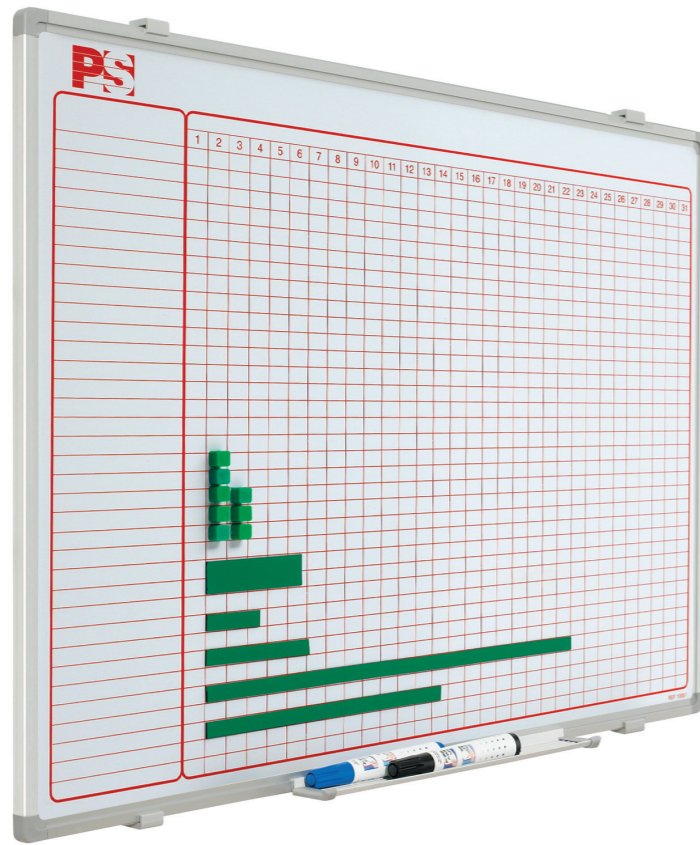

B
60 x 90

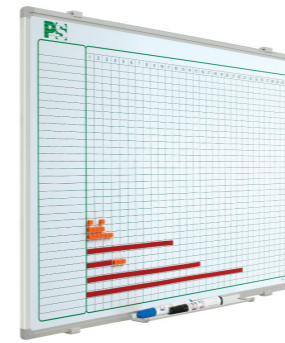

1000/11



1000/13



1000/14

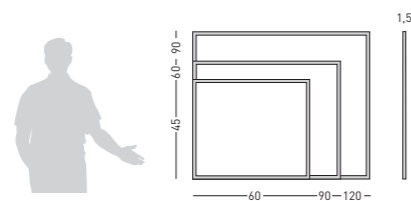

Model	Width	Height	Depth
1000/1	45 x 60	1,5	
1000/2	45 x 60	1,5	
1000/3	45 x 60	1,5	
1000/4	45 x 60	1,5	
1000/5	45 x 60	1,5	
1000/7	45 x 60	1,5	

Model	Width	Height	Depth
1000/11	60 x 90	1,5	
1000/13	60 x 90	1,5	
1000/14	60 x 90	1,5	
1000/15	60 x 90	1,5	

Model	Width	Height	Depth
1000/100	90 x 120	1,5	
1000/50	90 x 120	1,5	
1000/60	90 x 120	1,5	

ES | Planning magnético

Planning mural blanco serigrafiado, rotatable con rotuladores de borrado en seco, enmarcado con perfil de aluminio anodizado en color plata mate y cantoneras redondeadas grises. Incluye un cajetín reposarrotuladores de 30 cm.

FR | Planning magnétique

Planning magnétique quadrillé avec encadrement en aluminium anodisé couleur argent et coins arrondis en plastic gris. Surface en acier émaillé blanc effaçable à sec. Livré avec auget porte marqueurs de 30 cm. Quadrillage 1 x 1 cm. renforcé tous le 5 cm.

IT | Planning giornaliero magnetico

Planning magnetico con cornice in alluminio anodizzato ed angoli grigi in plastica. Superficie smaltata disponibile per scrittura con pennarelli a secco. Incluso porta penne da 30 cm.

GB | Magnetic planner

Magnetic planner equipped with silver anodised aluminium frame and grey plastic rounded corners. Enamelled surface is suitable for writing on with dry wipe board markers. A 30 cm. pen tray included.

DE | Magnetische Planungstafel

Planungstafel mit anodisiertem Aluminiumrahmen, silber eloxiert und abgerundeten grauen Kunststoffecken. Magnethaftende, lackierte Schreibtafeloberfläche mit trockenen abwischbaren Boardmarkern beschreibbar. Lieferung inklusive Stiftablage 30 cm. lang.

PO | Planning magnético

Planning de parede branco serigrafado, com superficie para escrita com marcadores de limpeza a seco, perfil em aluminio anodizado na cor prata mate e cantos arredondados cinzentos. Inclui suporte para marcadores de 30 cm.

C
90 x 120

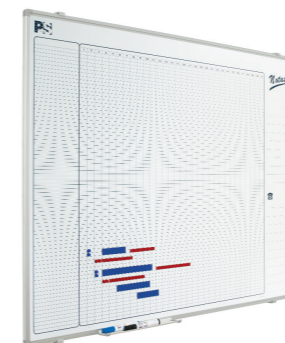

1000/100

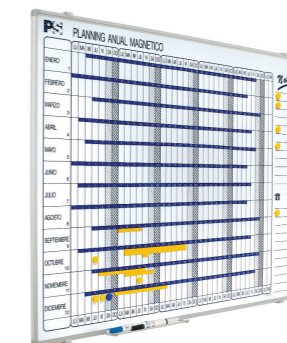

1000/50



1000/60

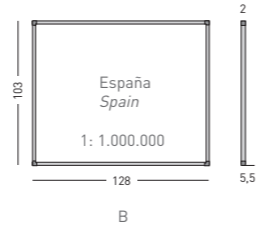
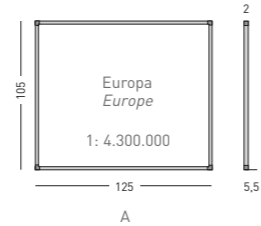
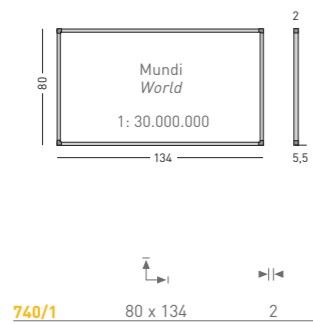

740/0	100 x 100	2
--------------	-----------	---

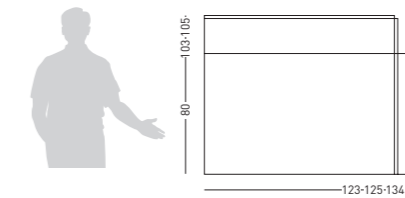

747/1	80 x 134	0,1
747/2	105 x 125	0,1
747/3	103 x 128	0,1

ES | Mapa magnético

Mapa magnético plastificado y enmarcado con perfil de aluminio anodizado en color plata mate y cantoneras redondeadas de plástico gris. Se pueden fabricar mapas a petición del cliente: regionales, provinciales, callejeros, etc. (suministrados por el cliente).

FR | Carte magnétique

Carte magnétique avec encadrement en aluminium anodisé argent aux coins arrondis en plastique gris. Plusieurs cartes sont disponibles: régional, province, routière, etc... Livré avec un auget porte marqueurs de 30 cm.

IT | Mappa magnetica

Mappa in plastica con cornice in alluminio anodizzato ed angoli grigi in plastica. Superficie magnetica, è possibile produrre mappe su richiesta del cliente; regionali, provinciali, stradali, ecc. Porta pennarelli da 30cm. Incluso.

GB | Magnetic map

Plastic map with silver anodised aluminium frame and grey plastic rounded corners. Magnet attachable surface, you can create your own maps to meet the demands of your customers: regional, provincial, road, etc. A 30 cm. pen tray included.

DE | Magnetaftende Mappe

Magnetaftende Mappe mit anodisiertem Aluminiumrahmen, silber eloxiert und abgerundeten grauen Kunststoffecken. Landkarten auf Anfrage des Kunden können hergestellt werden: regional, provinziell, straßen, etc. Lieferung inkl.: Stiftablage 30 cm. lang.

PO | Mapa magnético

Mapa magnético plastificado com perfil de alumínio anodizado na cor prata mate e cantos arredondados em plástico cinzento. Pode-se fabricar mapas por encomenda: regionais, de estradas, etc. Inclui suporte para marcadores com 30 cm.

ES | Mapa de papel plastificado

Mapas y planos de papel plastificados. Bajo demanda pueden solicitarse planos callejeros y mapas de otros países o ciudades.

GB | Mapa de papel plastificado

Maps in laminated paper. You can ask for different cities and/or countries

FR | Cartes et plans papier

Cartes et plans en papier laminé. Sur demande autres plans de rues et cartes d'autres pays ou villes. (consultez-nous).

DE | Eingeschweisste Karten und Pläne

Eingeschweisste Karten und Pläne aus Papier. Auf Bestellung liefern wir Karten und Pläne aller Länder und Städte.

IT | Cartina in carta plastificata

Mappe e piani in carta plastificata. Su richiesta si possono inserire piani particolari e mappe di altri paesi o città.

PO | Mapa em papel plastificado

Mapas e planos em papel plastificados. Por pedido podem ser solicitados planos de ruas e mapas de outros países ou cidades.



54



* Rotulador incluido.
* Pen included.

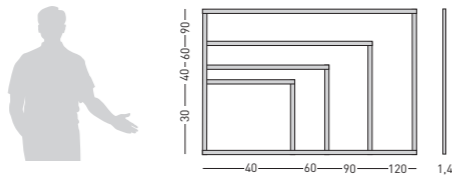

	↕	↔	Uts.
BL/VI/7271	30 x 40	1,4	40
BL/VI/7272	40 x 60	1,4	20
BL/VI/7273	60 x 90	1,4	10
BL/VI/7274	90 x 120	1,4	6

ES | Pizarra marco pino

Pizarra blanca plastificada y rotulable enmarcada con marco pino natural. Disponible en 4 medidas. Incluyen 1 rotulador con portarrotulador adhesivo y herrajes para sujeción.

GB | Pine frame chalkboard

Plastic white board with a wooden frame. Available in 4 sizes. Including a pen tray holder and it's pen to write plus the screws.

FR | Tableau cadre en pin

Tableau blanc en plastique pour feutres avec cadre en pin naturel. Disponible en 4 dimensions. Inclus 1 stylo et son auget porte feutre adhésif.

DE | Eingeschweiste weisse Tafel

Eingeschweiste weisse Tafel mit einem Pinienholzrahmen, zum beschriften. Verfügbar in 4 Größen. Beinhaltet einen Marker, einen Markerhalter sowie Beschläge zum Aufhängen.

IT | Lavagna con elemento in pino naturale

Lavagna bianca plastificata e scrivibile contornata con elemento in pino naturale. Disponibile in 4 misure. Include 1 pennarello con portapennarello adesivo e supporti per il fissaggio.

PO | Quadro com arco em madeira de pinho

Quadro branco plastificado e para utilização de marcadores com arco em madeira de pinho. Disponível em 4 medidas. Inclui 1 marcado com suporte adesivo e ferragens para a sua aplicação.

55



A	↕	↔	x
726/01	60 x 80	2,3	30
726/02	80 x 100	2,3	30
726/03	100 x 120	2,3	30
726/04	100 x 150	2,3	30

* Pizarra + tablero de corcho
* Board + cork board

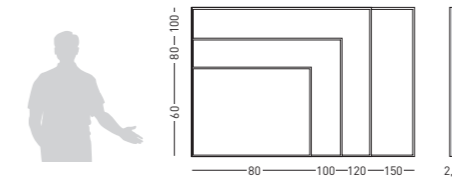

B	↕	↔	x
726/11	60 x 80	2,3	30
726/12	80 x 100	2,3	30
726/13	100 x 120	2,3	30
726/14	100 x 150	2,3	30

* Pizarra + tablero tapizado
* Board + felt board

ES | Combi boards

Combi board mitad Pizarra mural blanca lacada, mitad tablero de corcho enmarcado con perfil de aluminio anodizado en color plata mate y cantoneras redondeadas de plástico gris. Permite rotular en seco y uso de chinchetas. Incorpora cajetín de 30 cms.

GB | Combi boards

Combo board divided in 2 surfaces, one lacquered the other in natural cork with silver anodised framed with and plastic rounded corners. To use with dry pen marker and pinning up notes. A 30 cm pen tray is included.

FR | Combi tableau/liège

Tableau combi avec moitié laqué magnétique blanc et l'autre en liège, avec cadre en aluminium anodisé de couleur argent mat et coins arrondis en plastic gris. Pour feutres effaçables à sec et pour les punaises. Comprend un auget de 30 cm.

DE | Combi Board

Combi Board, halb Weisse Wandtafel, halb Korktafel, anodisierter Aluminiumrahmen, silbereloxiert, mit abgerundeten Kunststoffecken. Zum Gebrauch von trocken abwischbaren Markern und Reisszwecken. Stiftablage von 30cm.

IT | Combinato lavagna/sughero

Combinato metà lavagna da muro laccata bianca, metà bacheca in sughero con profilo in alluminio anodizzato in colore argento opaco e raccordi angolari arrotondati in plastica grigio. Permette di scrivere a secco o utilizzare puntine da disegno. Incorpora pannellino di 30 cm.

PO | Comboard quadro/cortiça

Combi Board metade Quadro branco de parede lacado, metade quadro de cortiça com perfil em alumínio anodizado na cor prata mate e cantos redondos em plástico cinzento. Permite a utilização de marcadores e de pineses. Inclui um suporte com 30 cm.



7001



ES | Bloc de papel liso
Bloc de papel liso de 25 hojas de 90 x 60 cm.

GB | Pad of plain paper
25 sheets 90 x 60 cm. plain white paper.

FR | Recharge papier uni
Bloc papier uni 25 feuilles 90 x 60 cm.

DE | Papierblock
Papierblock 25 Seiten 90 x 60 cm.

IT | Blocco da 25 fogli
Blocco da 25 fogli 90 x 60 cm.

PO | Bloco de papel liso
Bloco de papel liso com 25 folhas 90 x 60 cm.



KIT/2



ES | Maletín para conferencias
7005, 7006, 7008, 7009, 9003 (2 uds.) y 9004 (2 uds.).

GB | Conference accessory kit
7005, 7006, 7008, 7009, 9003 (2 un.) y 9004 (2 un.).

FR | Kit de conférences
7005, 7006, 7008, 7009, 9003 (2 un.) y 9004 (2 un.).

DE | Zubehör Kit
7005, 7006, 7008, 7009, 9003 (2 un.) y 9004 (2 un.).

IT | Kit per conferenze
7005, 7006, 7008, 7009, 9003 (2 un.) y 9004 (2 un.).

PO | Mala para conferências
7005, 7006, 7008, 7009, 9003 (2 un.) y 9004 (2 un.).



7005



ES | Rotuladores de pizarra
Pack 4 rotuladores borrado en seco (negro, rojo, verde y azul).

GB | Whiteboard markers
Pack 4 whiteboard markers (black, red, green and blue).

FR | Marqueurs effaçables à sec
Boîte 4 marqueurs effaçables à sec (noir, rouge, vert et bleu).

DE | Whiteboard-Markern
Lieferbar in 4 Farben sortiert (schwarz, rot, grün un blau).

IT | Pennarelli a secco
Confezione da 4 pezzi (nero, rosso, verde ed azzurro).

PO | Marcadores
Conjunto de 4 marcadores (preto, vermelho, azul e verde).



7012



ES | Borrador de aluminio
Borrador de aluminio para pizarras. Filtro intercambiable.

GB | Whiteboard eraser
Aluminium eraser for boards. The filters are replaceable.

FR | Effaceur d'aluminium
Effaceur en aluminium pour tableaux. Feutrine remplaçable.

DE | Whiteboard-Löscher
Aluminium Tafelwischer. Auswechselbarem Streifen.

IT | Cancellino in alluminio
Cancellino in alluminio.

PO | Apagador em alumínio
Apagador em alumínio.



7002

ES | Pinza portablocs
Pinza de 7 x 69 cm. sujeta a presión los blocs de papel.

GB | Pad holder
7 x 69 cm. pad holder.

FR | Barrete fixe papier
Barrete fixe papier 7 x 69 cm.

DE | Klemmleiste
7 x 69 cm. Klemmleiste, um das Flipchart Papier festzuhalten.

IT | Pinza ferma blocchi
Pinza ferma blocchi 7 x 69 cm.

PO | Pinça para blocos
Pinça para blocos de papel para quadros 7 x 69 cm.



7002/M



ES | Pinza portablocs magnética
Pinza de 6 x 65 cm. para superficies magnéticas.

GB | Magnetic pad holder
6 x 65 cm. long magnetic pad holder.

FR | Barrette fixe papier magnétique
Barrette fixe papier magnétique 6 x 65 cm.

DE | Magnethaftende Klemmleiste
Magnethaftende Klemmleiste 6 x 65 cm.

IT | Pinza ferma blocchi magnetica
Pinza ferma blocchi magnetica 6 x 65 cm.

PO | Pinça para blocos de papel magnética
Pinça para blocos de papel magnética para quadros 6 x 65 cm.



7019



ES | Portarrotuladores magnético
Portarrotuladores de plástico magnético para 4 rotuladores.

GB | Magnetic marker holder
Magnetic holder for 4 board markers.

FR | Porte marqueurs magnétique
Porte-marqueurs en plastique pour 4 marqueurs.

DE | Tafelschreiberhalter
Magnetischer Halter für 4 Tafelschreiber aus Kunststoff.

IT | Porta pennarelli verticale
Porta pennarelli verticale (per 4 pennarelli).

PO | Suporte magnético para marcadores
Suporte magnético vertical para marcadores (4 marcadores).

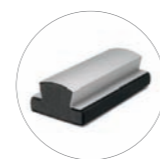

7006



ES | Borrador de aluminio magnético
Borrador de aluminio magnético. Filtro intercambiable.

GB | Magnetic whiteboard eraser
Magnetic aluminium eraser. The filters are replaceable.

FR | Effaceur magnétique
Effaceur magnétique en aluminium. Feutrine remplaçable.

DE | Magnetischer Whiteboard-löscher
Magnetischer Tafelwischer. Mit auswechselbaren Löschblättern.

IT | Cancellino magnetico in alluminio
Cancellino magnetico (alluminio).

PO | Apagador magnético alumínio
Apagador magnético (alumínio).

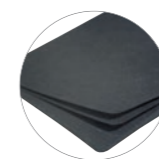

7006/1

ES | Recambio para borrador de aluminio
Bolsa de 20 uds. de filtros para borrador ref. 7006 y 7012.

GB | Aluminium eraser refills
Pack of 20 felt refills for aluminium erasers ref. 7006 / 7012.

FR | Feutrines remplacement pour effaceur
Jeu de 20 unités de feutrines pour effaceur ref. 7006 et 7012.

DE | Löschpapier für aluminium-tafelwischer
20 Löschblätter für Art. 7006 und 7012.

IT | Ricambio di feltri per cancellino
Ricambio di n. 20 feltri per cancellino in alluminio.

PO | Recarga para apagador
Recarga de 20 unidades para apagador.



7014



ES | Borrador de plástico
Borrador de plástico para pizarras. Filtro intercambiable.

GB | Plastic eraser
Plastic eraser for boards. The filters are replaceable.

FR | Effaceur de plastique
Effaceur en plastique pour tableaux. Feutrine remplaçable.

DE | Whiteboard-Löscher
Plastik Tafelwischer. Mit auswechselbarem Streifen.

IT | Cancellino in plastica
Cancellino in plastica 15 x 5 cm.

PO | Apagador de plástico
Apagador de plástico.



7003 - 7003/30

ES | Cajetin de aluminio
Cajetin de aluminio de 100 ó 30 cm.

GB | Aluminium tray
100 cm. or 30 cm. long aluminium pen tray.

FR | Auget porte marqueurs
Auget en aluminium, porte-marqueurs 100 cm. ou 30 cm.

DE | Aluminium stiftablage
Aluminium 100 oder 30 cm. mit Kunststoffecken.

IT | Porta pennarelli in alluminio
Porta pennarelli in alluminio 100 e 30 cm.

PO | Suporte para marcadores
Suporte para marcadores 100 o 30 cm.



7009



ES | Portarrotuladores magnético
Portarrotuladores de aluminio magnético de dos niveles.

GB | Pen tray holder
Two level magnetic aluminium pen tray holder.

FR | Auget porte marqueurs
Auget porte marqueurs d'aluminium avec deux niveaux.

DE | Stiftablage
Aluminiumstiftablage mit 2 niveaux.

IT | Porta pennarelli magnetico
Porta pennarelli magnetico.

PO | Suporte magnético para marcadores
Suporte magnético para marcadores.



7008

ES | Aerosol para pizarras
Aerosol para limpieza de pizarras blancas 200 ml.

GB | Whiteboard cleaner
Spray for cleaning of white boards 200 ml.

FR | Aerosol pour tableaux
Nettoyant aérosol 200 ml.

DE | Whiteboard - Grundreinigungs-spray
Sprühen für Grundreinigung von Schreibtafeln 200 ml.

IT | Spray per pulizia
Spray per pulizia lavagne 200 ml.

PO | Spray de limpeza para quadros
Spray de limpeza para quadros brancos 200 ml.

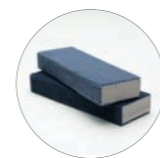

7014/1

ES | Recambio para borrador de plástico
2 uds. de filtros de recambio para borrador ref. 7014.

GB | Plastic eraser refill
Box of 2 refills for board eraser ref. 7014.

FR | Feutrines de remplacement effaceur
Jeu de 2 unités de feutrines pour effaceur réf. 7014.

DE | Löschpapier für plastik-tafelwischer
2 Löschblätter für Tafelwischer ref. 7014.

IT | Ricambio per cancellino
Ricambio per cancellino in plastica ref. 7014.

PO | Recarga para apagador de plástico
Recarga para apagador de plástico ref. 7014.



7015



ES | Borrador magnético "Design"
Obertura en el mango para guardar filtros y/o rotuladores.

GB | "Design" magnetic eraser
Open handle for keeping up dry erase pens &/or refills.

FR | Effaceur magnétique "Design"
Ouverture poignée pour garder feutrines et/ou marqueurs.

DE | Magnetischer Tafelwischer "Design"
Ouverture imm Griffium die Markers ref. 7015.

IT | Cancellino magnetico "Design"
Cancellino magnetico "Design".

PO | Apagador magnético "Design"
Apagador magnético "Design".

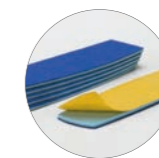

7015/1

ES | Recambios para borrador "Design"
Bolsa de 5 uds. de filtros para borrador "Design" ref. 7015.

GB | Refills for magnetic erasers
Pack of 5 refills for "Design" magnetic eraser ref. 7015.

FR | Effaceur magnétique "Design"
Boîte de 5 recharges feutrine brosse effaceur "Design" ref. 7015.

DE | Magnetischer Tafelwischer "Design"
5 Löschfilz-Ersatzblättl für "Design" Whischer ref. 7015.

IT | Ricambio di feltro "Design"
Ricambio di feltro per cancellino di "Design" (ref. 7015).

PO | Recarga para apagador "Design"
Recarga para apagador "Design" (ref. 7015).



9012 - 9014



ES | Banda magnética
Tira magnética de 0,9 x 50 cm. y 1,8 x 50 cm.

GB | Magnetic strips
Magnetic strip of 0,9 x 50 cm. / 1,8 x 50 cm.

FR | Bande magnétique
Bande magnétique 0,9 x 50 cm et 1,8 x 50 cm.

DE | Magnetbänder
Bandlänge 0,9 x 50 cm. / 1,8 x 50 cm.

IT | Striscia magnetica
Una striscia magnetica di 0,9 x 50 cm./1,8 x 50 cm.

PO | Banda magnética
Placa magnética 0,9 x 50 cm. / 1,8 x 50 cm.



9000



ES | Placa magnética
Placa de 50 x 60 cm.

GB | Magnetic plaque
Plaque 50 x 60 cm.

FR | Aimants
Boîte de 20 aimants carrés (0,9 cm.).

DE | Plaque magnétique
Plaque magnétique 50 x 60 cm.

IT | Piastra magnetica
Piastra 50 x 60 cm.

PO | Placa magnética
Placa magnética 50 x 60 cm.

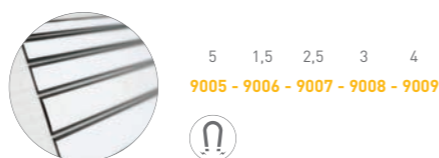

5

1,5

2,5

3

4

9005 - 9006 - 9007 - 9008 - 9009



ES | Portarrótulos magnético
Portarrótulos de 50 cm. de largo, magnéticos.

GB | Magnetic title holder
50 cm. long magnetic title holder.

FR | Porte-étiquettes magnétiques
Porte-étiquettes 50 cm.

DE | Magnetschilder
50 cm. länge magnethaftende Namenschilder.

IT | Supporto magnetico di titolo
Supporto magnetico di lunghezza di titolo di 50 cm.

PO | Porta rótulos magnético
Porta rótulos magnético longo de um título de 50 cm.

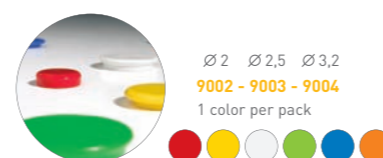

Ø 2

Ø 2,5

Ø 3,2

9002 - 9003 - 9004

1 color per pack



ES | Imanes
Caja de 6 uds. de imanes redondos (2, 2,5 y 3,2 cm.).

GB | Magnets
Pack of 6 circular magnets (2, 2,5 y 3,2 cm.).

FR | Aimants
Boîte de 6 aimants ronds (2, 2,5 y 3,2 cm.).

DE | Rundmagnete
6 Rundmagnete (2, 2,5 y 3,2 cm.).

IT | Magnetini tondi
Pacchetto di 6 pezzi magnetini tondi (2, 2,5 y 3,2 cm.).

PO | Magnéticos redondos
Bolsa 6 uds. de magnéticos redondos (2, 2,5 y 3,2 cm.).

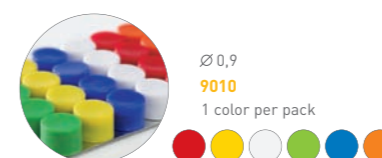

Ø 0,9

9010

1 color per pack



ES | Imanes
Caja de 20 uds. de imanes redondos (0,9 cm.).

GB | Magnets
Pack of 20 circular magnets (0,9 cm.).

FR | Aimants
Boîte de 20 aimants ronds (0,9 cm.).

DE | Rundmagnete
20 Rundmagnete (0,9 cm.).

IT | Magnetini tondi
Pacchetto di 20 pezzi magnetini tondi (0,9 cm.).

PO | Magnéticos redondos
Bolsa 20 uds. de magnéticos redondos (0,9 cm.).

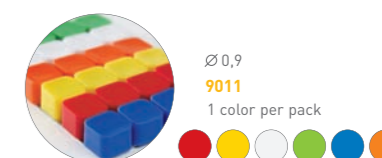

Ø 0,9

9011

1 color per pack



ES | Imanes
Caja de 20 uds. de imanes cuadrados (0,9 cm.).

GB | Magnets
Pack of 20 square magnets (0,9 cm.).

FR | Aimants
Boîte de 20 aimants carrés (0,9 cm.).

DE | Rundmagnete
20 Magnete Quadrat (0,9 cm.).

IT | Magnetini tondi
Pacchetto di 20 pezzi magnetini quadrato (0,9 cm.).

PO | Magnéticos redondos
Bolsa 20 uds. de magnéticos cuadrados (0,9 cm.).